

**P8Z68-V  
PRO**

**ASUS**<sup>®</sup>

**Motherboard**

E6696

Second Edition (V2)

June 2011

**Copyright © 2011 ASUSTeK COMPUTER INC. All Rights Reserved.**

No part of this manual, including the products and software described in it, may be reproduced, transmitted, transcribed, stored in a retrieval system, or translated into any language in any form or by any means, except documentation kept by the purchaser for backup purposes, without the express written permission of ASUSTeK COMPUTER INC. ("ASUS").

Product warranty or service will not be extended if: (1) the product is repaired, modified or altered, unless such repair, modification or alteration is authorized in writing by ASUS; or (2) the serial number of the product is defaced or missing.

ASUS PROVIDES THIS MANUAL "AS IS" WITHOUT WARRANTY OF ANY KIND, EITHER EXPRESS OR IMPLIED, INCLUDING BUT NOT LIMITED TO THE IMPLIED WARRANTIES OR CONDITIONS OF MERCHANTABILITY OR FITNESS FOR A PARTICULAR PURPOSE. IN NO EVENT SHALL ASUS, ITS DIRECTORS, OFFICERS, EMPLOYEES OR AGENTS BE LIABLE FOR ANY INDIRECT, SPECIAL, INCIDENTAL, OR CONSEQUENTIAL DAMAGES (INCLUDING DAMAGES FOR LOSS OF PROFITS, LOSS OF BUSINESS, LOSS OF USE OR DATA, INTERRUPTION OF BUSINESS AND THE LIKE), EVEN IF ASUS HAS BEEN ADVISED OF THE POSSIBILITY OF SUCH DAMAGES ARISING FROM ANY DEFECT OR ERROR IN THIS MANUAL OR PRODUCT.

SPECIFICATIONS AND INFORMATION CONTAINED IN THIS MANUAL ARE FURNISHED FOR INFORMATIONAL USE ONLY, AND ARE SUBJECT TO CHANGE AT ANY TIME WITHOUT NOTICE, AND SHOULD NOT BE CONSTRUED AS A COMMITMENT BY ASUS. ASUS ASSUMES NO RESPONSIBILITY OR LIABILITY FOR ANY ERRORS OR INACCURACIES THAT MAY APPEAR IN THIS MANUAL, INCLUDING THE PRODUCTS AND SOFTWARE DESCRIBED IN IT.

Products and corporate names appearing in this manual may or may not be registered trademarks or copyrights of their respective companies, and are used only for identification or explanation and to the owners' benefit, without intent to infringe.

**Offer to Provide Source Code of Certain Software**

This product may contain copyrighted software that is licensed under the General Public License ("GPL") and under the Lesser General Public License Version ("LGPL"). The GPL and LGPL licensed code in this product is distributed without any warranty. Copies of these licenses are included in this product.

You may obtain the complete corresponding source code (as defined in the GPL) for the GPL Software, and/or the complete corresponding source code of the LGPL Software (with the complete machine-readable "work that uses the Library") for a period of three years after our last shipment of the product including the GPL Software and/or LGPL Software, which will be no earlier than December 1, 2011, either (1) for free by downloading it from <http://support.asus.com/download>;

or

(2) for the cost of reproduction and shipment, which is dependent on the preferred carrier and the location where you want to have it shipped to, by sending a request to:

ASUSTeK Computer Inc.  
Legal Compliance Dept.  
15 Li Te Rd.,  
Beitou, Taipei 112  
Taiwan

In your request please provide the name, model number and version, as stated in the About Box of the product for which you wish to obtain the corresponding source code and your contact details so that we can coordinate the terms and cost of shipment with you.

The source code will be distributed WITHOUT ANY WARRANTY and licensed under the same license as the corresponding binary/object code.

This offer is valid to anyone in receipt of this information.

ASUSTeK is eager to duly provide complete source code as required under various Free Open Source Software licenses. If however you encounter any problems in obtaining the full corresponding source code we would be much obliged if you give us a notification to the email address [gpl@asus.com](mailto:gpl@asus.com), stating the product and describing the problem (please do NOT send large attachments such as source code archives etc to this email address).

# Contents

Notices .....	vi
Safety information.....	vii
About this guide.....	viii
P8Z68-V PRO specifications summary .....	x

## Chapter 1: Product introduction

1.1	Welcome! .....	1-1
1.2	Package contents.....	1-1
1.3	Special features.....	1-2
1.3.1	Product highlights.....	1-2
1.3.2	Dual Intelligent Processors 2 with DIGI+ VRM .....	1-3
1.3.3	ASUS Exclusive Features .....	1-4
1.3.4	ASUS Quiet Thermal Solution.....	1-4
1.3.5	ASUS EZ DIY.....	1-5
1.3.6	Other special features .....	1-5

## Chapter 2: Hardware information

2.1	Before you proceed .....	2-1
2.2	Motherboard overview.....	2-2
2.2.1	Motherboard layout .....	2-2
2.2.2	Central Processing Unit (CPU) .....	2-4
2.2.3	System memory .....	2-5
2.2.4	Expansion slots .....	2-12
2.2.5	Onboard switches .....	2-14
2.2.6	Onboard LEDs .....	2-18
2.2.7	Jumper .....	2-20
2.2.8	Internal connectors.....	2-21
2.3	Building your computer system .....	2-30
2.3.1	Additional tools and components to build a PC system .....	2-30
2.3.2	CPU installation.....	2-31
2.3.3	CPU heatsink and fan assembly installation .....	2-33
2.3.4	DIMM installation.....	2-35
2.3.5	Motherboard installation.....	2-36
2.3.6	ATX Power connection .....	2-38
2.3.7	SATA device connection.....	2-39
2.3.8	Front I/O Connector .....	2-40
2.3.9	Expansion Card installation.....	2-41
2.3.10	Rear panel connection .....	2-42
2.3.11	Audio I/O connections .....	2-45

# Contents

2.4	Starting up for the first time.....	2-48
2.5	Turning off the computer.....	2-48

## Chapter 3: BIOS setup

3.1	Knowing BIOS.....	3-1
3.2	BIOS setup program.....	3-1
3.2.1	EZ Mode.....	3-2
3.2.2	Advanced Mode.....	3-3
3.3	Main menu.....	3-5
3.4	Ai Tweaker menu.....	3-7
3.5	Advanced menu.....	3-14
3.5.1	CPU Configuration.....	3-15
3.5.2	System Agent Configuration.....	3-17
3.5.3	PCH Configuration.....	3-17
3.5.4	SATA Configuration.....	3-18
3.5.5	USB Configuration.....	3-20
3.5.6	Onboard Devices Configuration.....	3-21
3.5.7	APM.....	3-24
3.6	Monitor menu.....	3-25
3.7	Boot menu.....	3-28
3.8	Tools menu.....	3-29
3.8.1	ASUS EZ Flash 2 Utility.....	3-29
3.8.2	ASUS O.C. Profile.....	3-30
3.9	Exit menu.....	3-31
3.10	Updating BIOS.....	3-32
3.10.1	ASUS Update utility.....	3-32
3.10.2	ASUS EZ Flash 2 utility.....	3-35
3.10.3	ASUS CrashFree BIOS 3 utility.....	3-36
3.10.4	ASUS BIOS Updater.....	3-37

## Chapter 4: Software support

4.1	Installing an operating system.....	4-1
4.2	Support DVD information.....	4-1
4.2.1	Running the support DVD.....	4-1
4.2.2	Obtaining the software manuals.....	4-2
4.3	Software information.....	4-3
4.3.1	AI Suite II.....	4-3
4.3.2	DIGI+ VRM.....	4-4
4.3.3	BT GO!.....	4-5
4.3.4	TurboV EVO.....	4-7

# Contents

4.3.5	EPU.....	4-12
4.3.6	ASUS FAN Xpert.....	4-13
4.3.7	ASUS Probe II.....	4-14
4.3.8	Ai Charger+.....	4-15
4.3.9	Audio configurations.....	4-16
<b>4.4</b>	<b>RAID configurations .....</b>	<b>4-17</b>
4.4.1	RAID definitions .....	4-17
4.4.2	Installing Serial ATA hard disks.....	4-18
4.4.3	Setting the RAID item in BIOS .....	4-18
4.4.4	Intel® Rapid Storage Technology Option ROM utility .....	4-18
<b>4.5</b>	<b>Creating a RAID driver disk.....</b>	<b>4-24</b>
4.5.1	Creating a RAID driver disk without entering the OS.....	4-24
4.5.2	Creating a RAID driver disk in Windows®.....	4-24
4.5.3	Installing the RAID driver during Windows® OS installation.....	4-25
4.5.4	Using a USB floppy disk drive.....	4-26
 <b>Chapter 5: Multiple GPU technology support</b>		
<b>5.1</b>	<b>ATI® CrossFireX™ technology.....</b>	<b>5-1</b>
5.1.1	Requirements.....	5-1
5.1.2	Before you begin.....	5-1
5.1.3	Installing two CrossFireX™ graphics cards .....	5-2
5.1.4	Installing the device drivers.....	5-3
5.1.5	Enabling the ATI® CrossFireX™ technology .....	5-3
<b>5.2</b>	<b>NVIDIA® SLI™ technology.....</b>	<b>5-4</b>
5.2.1	Requirements.....	5-4
5.2.2	Installing two SLI-ready graphics cards .....	5-4
5.2.3	Installing the device drivers.....	5-5
5.2.4	Enabling the NVIDIA® SLI™ technology .....	5-5
<b>5.3</b>	<b>LucidLogix® Virtu™ solution.....</b>	<b>5-8</b>
5.3.1	Hardware installation.....	5-8
5.3.2	Software configuration .....	5-9

# Notices

## Federal Communications Commission Statement

This device complies with Part 15 of the FCC Rules. Operation is subject to the following two conditions:

- This device may not cause harmful interference, and
- This device must accept any interference received including interference that may cause undesired operation.

This equipment has been tested and found to comply with the limits for a Class B digital device, pursuant to Part 15 of the FCC Rules. These limits are designed to provide reasonable protection against harmful interference in a residential installation. This equipment generates, uses and can radiate radio frequency energy and, if not installed and used in accordance with manufacturer's instructions, may cause harmful interference to radio communications. However, there is no guarantee that interference will not occur in a particular installation. If this equipment does cause harmful interference to radio or television reception, which can be determined by turning the equipment off and on, the user is encouraged to try to correct the interference by one or more of the following measures:

- Reorient or relocate the receiving antenna.
- Increase the separation between the equipment and receiver.
- Connect the equipment to an outlet on a circuit different from that to which the receiver is connected.
- Consult the dealer or an experienced radio/TV technician for help.



---

The use of shielded cables for connection of the monitor to the graphics card is required to assure compliance with FCC regulations. Changes or modifications to this unit not expressly approved by the party responsible for compliance could void the user's authority to operate this equipment.

---

## Canadian Department of Communications Statement

This digital apparatus does not exceed the Class B limits for radio noise emissions from digital apparatus set out in the Radio Interference Regulations of the Canadian Department of Communications.

This class B digital apparatus complies with Canadian ICES-003.

## REACH

Complying with the REACH (Registration, Evaluation, Authorisation, and Restriction of Chemicals) regulatory framework, we published the chemical substances in our products at ASUS REACH website at <http://csr.asus.com/english/REACH.htm>.



---

**DO NOT** throw the motherboard in municipal waste. This product has been designed to enable proper reuse of parts and recycling. This symbol of the crossed out wheeled bin indicates that the product (electrical and electronic equipment) should not be placed in municipal waste. Check local regulations for disposal of electronic products.

---



---

**DO NOT** throw the mercury-containing button cell battery in municipal waste. This symbol of the crossed out wheeled bin indicates that the battery should not be placed in municipal waste.

---

# Safety information

## Electrical safety

- To prevent electrical shock hazard, disconnect the power cable from the electrical outlet before relocating the system.
- When adding or removing devices to or from the system, ensure that the power cables for the devices are unplugged before the signal cables are connected. If possible, disconnect all power cables from the existing system before you add a device.
- Before connecting or removing signal cables from the motherboard, ensure that all power cables are unplugged.
- Seek professional assistance before using an adapter or extension cord. These devices could interrupt the grounding circuit.
- Ensure that your power supply is set to the correct voltage in your area. If you are not sure about the voltage of the electrical outlet you are using, contact your local power company.
- If the power supply is broken, do not try to fix it by yourself. Contact a qualified service technician or your retailer.

## Operation safety

- Before installing the motherboard and adding devices on it, carefully read all the manuals that came with the package.
- Before using the product, ensure all cables are correctly connected and the power cables are not damaged. If you detect any damage, contact your dealer immediately.
- To avoid short circuits, keep paper clips, screws, and staples away from connectors, slots, sockets and circuitry.
- Avoid dust, humidity, and temperature extremes. Do not place the product in any area where it may become wet.
- Place the product on a stable surface.
- If you encounter technical problems with the product, contact a qualified service technician or your retailer.

# About this guide

This user guide contains the information you need when installing and configuring the motherboard.

## How this guide is organized

This guide contains the following parts:

- **Chapter 1: Product introduction**  
This chapter describes the features of the motherboard and the new technology it supports.
- **Chapter 2: Hardware information**  
This chapter lists the hardware setup procedures that you have to perform when installing system components. It includes description of the switches, jumpers, and connectors on the motherboard.
- **Chapter 3: BIOS setup**  
This chapter tells how to change system settings through the BIOS Setup menus. Detailed descriptions of the BIOS parameters are also provided.
- **Chapter 4: Software support**  
This chapter describes the contents of the support DVD that comes with the motherboard package and the software.
- **Chapter 5: Multiple GPU technology support**  
This chapter describes how to install and configure multiple ATI® CrossFireX™ and NVIDIA® SLI™ graphics cards.

## Where to find more information

Refer to the following sources for additional information and for product and software updates.

1. **ASUS websites**  
The ASUS website provides updated information on ASUS hardware and software products. Refer to the ASUS contact information.
2. **Optional documentation**  
Your product package may include optional documentation, such as warranty flyers, that may have been added by your dealer. These documents are not part of the standard package.



## Conventions used in this guide

To ensure that you perform certain tasks properly, take note of the following symbols used throughout this manual.



**DANGER/WARNING:** Information to prevent injury to yourself when trying to complete a task.



**CAUTION:** Information to prevent damage to the components when trying to complete a task.



**IMPORTANT:** Instructions that you **MUST** follow to complete a task.



**NOTE:** Tips and additional information to help you complete a task.

## Typography

### **Bold text**

Indicates a menu or an item to select.

### *Italics*

Used to emphasize a word or a phrase.

### <Key>

Keys enclosed in the less-than and greater-than sign means that you must press the enclosed key.

Example: <Enter> means that you must press the Enter or Return key.

### <Key1> + <Key2> + <Key3>

If you must press two or more keys simultaneously, the key names are linked with a plus sign (+).

Example: <Ctrl> + <Alt> + <Del>

## P8Z68-V PRO specifications summary

<b>CPU</b>	<p>LGA1155 socket for Intel® 2nd Generation Core™ i7 / Core™ i5 / Core™ i3 Processors</p> <p>Supports 32nm CPU</p> <p>Supports Intel® Turbo Boost Technology 2.0*</p> <p>* The Intel® Turbo Boost Technology 2.0 support depends on CPU types.</p> <p>** Refer to <a href="http://www.asus.com">www.asus.com</a> for the Intel CPU support list.</p>
<b>Chipset</b>	Intel® Z68 Express Chipset
<b>Memory</b>	<p>4 x DIMM, max. 32GB, DDR3 2200(O.C.)* / 2133(O.C.) / 1866(O.C.) / 1600 / 1333 / 1066 MHz, non-ECC, un-buffered memory</p> <p>Dual channel memory architecture</p> <p>Supports Intel® Extreme Memory Profile (XMP)</p> <p>* Due to CPU behavior, DDR3 2200/2000/1800 MHz memory module will run at DDR3 2133/1866/1600 MHz frequency as default.</p> <p>** Hyper DIMM support is subject to the physical characteristics of individual CPUs. Some hyper DIMMs only support one DIMM per channel. Please refer to Memory QVL for details.</p> <p>*** Refer to <a href="http://www.asus.com">www.asus.com</a> or this user manual for the Memory QVL (Qualified Vendors Lists)</p>
<b>Expansion slots</b>	<p>2 x PCI Express 2.0 x16 slots (single at x16 or dual at x8 / x8 mode)</p> <p>1 x PCI Express 2.0 x16 slot [black] (max. at x4 mode, compatible with PCIe x1 and x4 devices)</p> <p>2 x PCI Express 2.0 x1 slots</p> <p>2 x PCI slots</p> <p>* The PCIe x16_3 slot shares bandwidth with PCIe x1_1 slot, PCIe x1_2 slot, USB3_34 and eSATA. The PCIe x16_3 default setting is in x1 mode.</p>
<b>VGA</b>	<p>Multi-VGA output support: HDMI, DVI-D, and RGB ports</p> <p>Supports HDMI with max. resolution 1920 x 1200 @60Hz</p> <p>Supports DVI with max. resolution 1920 x 1200 @60Hz</p> <p>Supports RGB with max. resolution 2048 x 1536 @75Hz</p> <p>Maximum shared memory of 1748MB</p>
<b>Multi-GPU support</b>	<p>Supports NVIDIA® Quad-GPU SLI™ Technology</p> <p>Supports ATI® Quad-GPU CrossFireX™ Technology</p> <p>Supports LucidLogix® Virtu™ Technology*</p> <p>* LucidLogix® Virtu™ supports Windows® 7 operating systems.</p>
<b>Storage</b>	<p><b>Intel® Z68 Express Chipset</b></p> <ul style="list-style-type: none"> <li>- 2 x SATA 6.0 Gb/s ports (gray)</li> <li>- 4 x SATA 3.0 Gb/s ports (blue)</li> <li>- Intel® Rapid Storage Technology supports RAID 0, 1, 5, and 10</li> <li>- Supports Intel® Smart Response Technology on 2<sup>nd</sup> generation Intel® Core™ processor family*</li> <li>* Intel® Smart Response Technology supports Windows® 7/ Vista operating systems.</li> </ul> <p><b>Marvell® PCIe SATA 6.0 Gb/s controller**</b></p> <ul style="list-style-type: none"> <li>- 2 x SATA 6.0 Gb/s ports (navy blue)</li> </ul> <p><b>JMicron® JMB362 SATA controller**</b></p> <ul style="list-style-type: none"> <li>- 1 x eSATA 3.0 Gb/s port</li> </ul> <p>** These SATA ports are for data hard drives only. ATAPI devices are not supported.</p>
<b>LAN</b>	Intel® 82579 Gigabit LAN - Dual interconnect between the Integrated LAN controller and Physical Layer (PHY)

(continued on the next page)

## P8Z68-V PRO specifications summary

<b>Bluetooth</b>	Bluetooth v2.1 + EDR ASUS BT GO! Utility
<b>Audio</b>	Realtek® ALC892 8-channel High Definition Audio CODEC <ul style="list-style-type: none"> <li>- Absolute Pitch 192khz/24bit True BD Lossless Sound</li> <li>- BD Audio Layer Content Protection</li> <li>- DTS Surround Sensation UltraPC</li> <li>- Supports Jack-Detection, Multi-Streaming and Front Panel Jack-Retasking</li> <li>- Optical S/PDIF Out ports at back I/O</li> </ul>
<b>IEEE 1394</b>	VIA® VT6308P controller supports 2 x IEEE 1394a ports (2 headers at mid-board)
<b>USB</b>	<b>2 x ASMedia USB 3.0 controllers</b> <ul style="list-style-type: none"> <li>- 2 x USB 3.0 ports at mid-board for front panel support (blue)</li> <li>- 2 x USB 3.0 ports at back panel (blue)</li> </ul> <b>Intel® Z68 Express Chipset</b> <ul style="list-style-type: none"> <li>- 12 x USB 2.0 ports (6 ports at mid-board, 6 ports at back panel)</li> </ul>
<b>ASUS unique features</b>	<b>ASUS Dual Intelligent Processors 2 with DIGI+ VRM:</b> <p><b>ASUS DIGI+ VRM</b></p> <ul style="list-style-type: none"> <li>- Industry leading Digital 16-phase* Power Design</li> <li>- ASUS DIGI+ VRM Utility</li> </ul> <p>* 12-phase for CPU, 4-phase for iGPU</p> <p><b>ASUS EPU</b></p> <ul style="list-style-type: none"> <li>- EPU, EPU switch</li> </ul> <p><b>ASUS TPU</b></p> <ul style="list-style-type: none"> <li>- Auto Tuning, TurboV, GPU Boost, TPU switch</li> </ul> <p><b>ASUS BT GO! (Bluetooth):</b></p> <ul style="list-style-type: none"> <li>- Folder Sync, BT Transfer, Shot &amp; Send, BT to Net, Music Player, Personal Manager</li> </ul> <p><b>ASUS BT Turbo Remote:</b></p> <ul style="list-style-type: none"> <li>- Exclusive Smartphone Interface supporting iPhone, Android, Windows Mobile and Symbian systems</li> </ul> <p><b>ASUS Exclusive Features</b></p> <ul style="list-style-type: none"> <li>- ASUS UEFI BIOS EZ Mode featuring friendly graphics user interface</li> <li>- MemOK!</li> <li>- AI Suite II</li> <li>- AI Charger+</li> <li>- Anti Surge</li> <li>- Disk Unlocker</li> </ul> <p><b>ASUS Quiet Thermal Solutions</b></p> <ul style="list-style-type: none"> <li>- ASUS Fanless Design: Heat-sink solution</li> <li>- ASUS Fan Xpert</li> </ul> <p><b>ASUS EZ DIY</b></p> <ul style="list-style-type: none"> <li>- ASUS Q-Shield</li> <li>- ASUS Q-Connector</li> <li>- ASUS O.C. Tuner</li> <li>- ASUS CrashFree BIOS 3</li> <li>- ASUS EZ Flash 2</li> </ul>
<b>ASUS Q-Design</b>	ASUS Q-LED (CPU, DRAM, VGA, Boot Device LED) ASUS Q-Slot ASUS Q-DIMM

(continued on the next page)

# P8Z68-V PRO specifications summary

<b>ASUS exclusive overclocking features</b>	<p><b>Precision Tweaker 2</b></p> <ul style="list-style-type: none"> <li>- vCore: Adjustable CPU voltage at 0.005V increment</li> <li>- vCCIO: Adjustable I/O voltage at 0.00625V increment</li> <li>- vDRAM Bus: 160-step memory voltage control</li> <li>- vPCH: 90-step chipset voltage control</li> <li>- vCPU_PLL: 160-step CPU &amp; PLL voltage control</li> </ul> <p><b>SFS (Stepless Frequency Selection)</b></p> <ul style="list-style-type: none"> <li>- BCLK/PCIE frequency tuning from 80MHz up to 300MHz at 0.1MHz increment</li> </ul> <p><b>Overclocking protection</b></p> <ul style="list-style-type: none"> <li>- ASUS C.P.R. (CPU Parameter Recall)</li> </ul>
<b>Back panel I/O ports</b>	<p>1 x Optical S/PDIF Out port          1 x Bluetooth module          1 x eSATA port          1 x Intel® LAN (RJ-45) port          2 x USB 3.0/2.0 ports (blue)          6 x USB 2.0/1.1 ports          1 x HDMI port          1 x DVI port          1 x VGA port          8-channel Audio I/O ports</p>
<b>Internal I/O connectors</b>	<p>1 x USB 3.0/2.0 connectors support additional 2 USB ports (19-pin)          3 x USB 2.0/1.1 connectors support additional 6 USB ports          4 x SATA 6.0 Gb/s connectors (2 x gray, 2 x navy blue)          4 x SATA 3.0 Gb/s connectors (blue)          2 x CPU Fan connector (4-pin)          2 x Chassis Fan connectors (1 x 4-pin, 1 x 3-pin)          2 x Power Fan connector (3-pin)          2 x IEEE1394a connector          1 x Front panel audio connector          1 x S/PDIF Out header          1 x 24-pin EATX Power connector          1 x 8-pin EATX 12V Power connector          1 x System Panel (Q-Connector)          1 x MemOK! button          1 x EPU switch          1 x TPU switch</p>
<b>BIOS features</b>	<p>64 Mb Flash ROM, UEFI AMI BIOS, PnP, DMI 2.0, WfM 2.0, SM BIOS 2.5, ACPI 2.0a, Multi-language BIOS, ASUS EZ Flash 2, ASUS CrashFree BIOS 3, F12 PrintScreen Function</p>
<b>Manageability</b>	<p>WfM 2.0, DMI 2.0, WOL by PME, WOR by PME, PXE</p>
<b>Support DVD contents</b>	<p>Drivers          ASUS Utilities          ASUS Update          Anti-virus software (OEM version)</p>
<b>Form factor</b>	<p>ATX form factor: 12 in. x 9.6 in. (30.5 cm x 24.4 cm)</p>

\*Specifications are subject to change without notice.

# Chapter 1

## 1.1 Welcome!





Thank you for buying an ASUS® P8Z68-V PRO motherboard!

The motherboard delivers a host of new features and latest technologies, making it another standout in the long line of ASUS quality motherboards!

Before you start installing the motherboard, and hardware devices on it, check the items in your package with the list below.

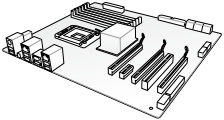
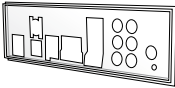
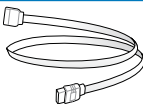
## 1.2 Package contents

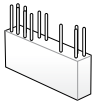
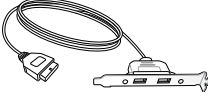
Check your motherboard package for the following items.

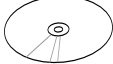
	
<b>ASUS P8Z68-V PRO motherboard</b>	<b>1 x ASUS Q-Shield</b>
	
<b>2 x Serial ATA 3.0 Gb/s cables 2 x Serial ATA 6.0 Gb/s cables</b>	<b>1 x ASUS SLI™ bridge connector</b>
	
<b>1 x 2-in-1 ASUS Q-Connector kit</b>	<b>1x ASUS USB 3.0 Bracket</b>
	
<b>User guide</b>	<b>Support DVD</b>



- If any of the above items is damaged or missing, contact your retailer.
- The illustrated items above are for reference only. Actual product specifications may vary with different models.

## 1.3 Special features

### 1.3.1 Product highlights

#### LGA1155 socket for Intel® Second Generation Core™ i7 / Core™ i5 / Core™ i3 Processors

This motherboard supports the Intel® second generation Core™ i7 / Core™ i5 / Core™ i3 processors in LGA1155 package with memory and PCI Express controllers integrated to support 2-channel (4 DIMMs) DDR3 memory and 16 PCI Express 2.0 lanes. This provides great graphics performance. Intel® second generation Core™ i7 / Core™ i5 / Core™ i3 processors are among the most powerful and energy efficient CPUs in the world.

#### Intel® Z68 Express Chipset

The Intel® Z68 Express Chipset is the latest single-chipset design to support the new 1155 socket Intel® Core™ i7 / Core™ i5 / Core™ i3 second generation processors. It uses serial point-to-point links, which allows increased bandwidth and stability, and provides an improved performance. It also provides two SATA 6.0 Gb/s and four SATA 3.0 Gb/s ports for faster data retrieval at double the bandwidth of current bus systems. Moreover, Intel® Z68 Express Chipset also supports iGPU function, letting users enjoy the latest Intel integrated graphic performance.

#### Intel® Smart Response Technology

Intel® Smart Response Technology boosts overall system performance. It uses an installed fast SSD (min 18.6GB available capacity) as a cache for frequently accessed data. Harnesses the combination of SSD-like performance and response with hard drive capacity, running 4X faster than an HDD-only system.

\* Intel® Smart Response Technology supports Windows® 7/ Vista operating systems.

\*\* Intel® Smart Response Technology is supported by 2nd generation Intel® Core™ processor family.

\*\*\* Operating systems must be installed on the HDD to launch Intel® Smart Response Technology. The capacity of the SSD is reserved for caching function.

#### Quad-GPU SLI™ and Quad-GPU CrossFireX™ Support

The motherboard's powerful Intel® Z68 platform optimizes PCIe allocation in multiple-GPU configurations of either SLI™ or CrossFireX™. This allows you to enjoy a never before-experienced brand new gaming style.

#### Dual-Channel DDR3 2200(O.C.) / 2133(O.C.) / 1866(O.C.) / 1600 / 1333 / 1066 Support

The motherboard supports DDR3 memory that features data transfer rates of 2200(O.C.) / 2133(O.C.) / 1866 / 1600 / 1333 / 1066 MHz to meet the higher bandwidth requirements of the latest 3D graphics, multimedia, and Internet applications. The dual-channel DDR3 architecture enlarges the bandwidth of your system memory to boost system performance.

\* Due to CPU behavior, DDR3 2200/2000/1800 MHz memory module will run at DDR3 2133/1866/1600 MHz frequency as default.

## Complete USB 3.0 Integration

ASUS facilitates strategic USB 3.0 accessibility for both the front and rear panel - 4 USB 3.0 ports in total. Experience the latest plug & play connectivity at speeds up to 10 times faster than USB 2.0. The P8Z68-V PRO affords greater convenience to high speed connectivity.

## Extra SATA 6.0 Gb/s Support

The Intel® Z68 Express Chipset natively supports the next-generation Serial ATA (SATA) interface, delivering up to 6.0 Gb/s data transfer. ASUS provides extra SATA 6.0 Gb/s ports with enhanced scalability, faster data retrieval, and double the bandwidth of current bus systems.

### 1.3.2 Dual Intelligent Processors 2 with DIGI+ VRM

The world's first Dual Intelligent Processors from ASUS pioneered the use of two onboard chips—EPU (Energy Processing Unit) and TPU (TurboV Processing Unit). New generation Dual Intelligent Processors 2 with DIGI+ VRM digital power design launch control into a new era, empowering users with superior flexibility and perfect precision to ensure optimized performance, extreme system stability and greater power efficiency.

#### DIGI+ VRM

New ASUS DIGI+ VRM upgrades motherboard power delivery to a digital standard. The 16 digital architecture delivers twice the precision power. With iGPU on P8Z68-V PRO motherboards, DIGI+ VRM intelligently adjust Vcore PWM, integrated graphics voltages and frequency modulation to minimize power loss through BIOS tuning and the exclusive user interface. It increases overclocking range while performance reaches its full potential, adjusting frequencies dynamically and cutting EM interference by half to enhance system stability through enabled spread spectrum. The DIGI+ VRM digital power design empowers users with superior flexibility and perfect precision to ensure optimized performance. extreme system stability, and greater power efficiency.

#### 2X Precise Power Control

ASUS DIGI+ VRM delivers twice the precision power, intelligently adjusting PWM voltage and frequency modulation to minimize power loss while performance reaches its full potential.

#### 2X Less Radiation

ASUS DIGI+ VRM adjusts frequencies dynamically, cutting radiation by half to enhance system stability through enabling spread spectrum.

#### TPU

Unleash your performance with ASUS' simple onboard switch or AI Suite II utility. The TPU chip offers precise voltage control and advanced monitoring through Auto Tuning and TurboV functions. Auto Tuning offers a user friendly way to automatically optimize the system for fast, yet stable clock speeds, while TurboV enables unlimited freedom to adjust CPU frequencies and ratios for optimized performance in diverse situations.

## EPU

Tap into the world's first real-time PC power saving chip through a simple onboard switch or AI Suite II utility. Get total system-wide energy optimization by automatically detecting current PC loadings and intelligently moderating power consumption. This also reduces fan noise and extends component longevity!

### 1.3.3 ASUS Exclusive Features

#### GPU Boost

GPU Boost accelerates the integrated GPU for extreme graphics performance. The user-friendly interface facilitates flexible frequency adjustments. It easily delivers stable system-level upgrades for every use.

#### BT GO! (Bluetooth)

Onboard Bluetooth wireless design enables smart connectivity to Bluetooth devices with no additional adapter. ASUS BT GO! comes with 7 special functions that offer significant breakthrough in Bluetooth evolution, including Folder Sync, BT Transfer, BT Turbo Remote, BT-to-Net, Music Player, Shot and Send, and Personal Manager. All are accessible through the exclusive, user-friendly ASUS interface.

#### MemOK!

MemOK! quickly ensures memory boot compatibility. This remarkable memory rescue tool requires a mere push of a button to patch memory issues. MemOK! determines failsafe settings and dramatically improves your system boot success.

#### AI Suite II

With its user-friendly interface, ASUS AI Suite II consolidates all the exclusive ASUS features into one simple to use software package. It allows users to supervise overclocking, energy management, fan speed control, voltage and sensor readings, and even interact with mobile devices via Bluetooth. This all-in-one software offers diverse and ease to use functions, with no need to switch back and forth between different utilities.

### 1.3.4 ASUS Quiet Thermal Solution

#### ASUS Fanless Design—Heat-sink solution

The stylish heatsink features 0-dB thermal solution that offers users a noiseless PC environment. Not only the beautiful shape upgrades the visual enjoyment for motherboard users, but also the heatsink design lowers the temperature of the chipset and power phase area through high efficient heat-exchange. Combined with usability and aesthetics, the ASUS stylish heatsink will give users an extremely silent and cooling experience with the elegant appearance!

#### ASUS Fan Xpert

ASUS Fan Xpert intelligently allows you to adjust both the CPU and chassis fan speeds according to different ambient temperatures caused by different climate conditions in different geographic regions and your PC's loading. The built-in variety of useful profiles offer flexible controls of fan speed to achieve a quiet and cool environment.



### 1.3.5 ASUS EZ DIY

#### ASUS UEFI BIOS (EZ Mode)

ASUS UEFI BIOS offers a user-friendly interface that goes beyond traditional keyboard-only BIOS controls to enable more flexible and convenient mouse input. Users can easily navigate the UEFI BIOS with the smoothness of their operating system. Quick and simple overclocking and setup sharing is facilitated by the F12 hotkey BIOS snapshot feature. The exclusive EZ Mode displays frequently-accessed setup info, while the Advanced Mode is for experienced performance enthusiasts that demand far more intricate system control, including detailed DRAM information.

#### **Supports hard drives over 2.2TB**

ASUS UEFI BIOS natively supports hard drives larger than 2.2TB in 64-bit, with full storage space utilization helping deliver far more exciting computing than traditional BIOS versions.

#### ASUS Q-Design

ASUS Q-Design enhances your DIY experience. All of Q-LED, Q-Slot and Q-DIMM design speed up and simplify the DIY process!

#### ASUS Q-Shield

The specially designed ASUS Q-Shield does without the usual "fingers" - making it convenient and easy to install. With better electric conductivity, it ideally protects your motherboard against static electricity and shields it against Electronic Magnetic Interference (EMI).

#### ASUS Q-Connector

ASUS Q-Connector allows you to easily connect or disconnect the chassis front panel cables to the motherboard. This unique module eliminates the trouble of connecting the system panel cables one at a time and avoiding wrong cable connections.

#### ASUS EZ-Flash 2

ASUS EZ Flash 2 is a user-friendly utility that allows you to update the BIOS without using a bootable floppy disk or an OS-based utility.

### 1.3.6 Other special features

#### LucidLogix® Virtu™

LucidLogix® Virtu™ is designed for the Intel® Sandy Bridge platform's powerful integrated graphics. Its GPU virtualization dynamically assigns tasks to the best available graphics resources based on power, performance and system load on Windows® 7 based PCs. It allows users to fully utilize the unique capabilities of advanced Sandy Bridge multimedia features alongside the high end 3D rendering performance provided by installed graphics cards. When no discrete graphics are needed, the graphics card is put in idle mode to lower utilization, heat, fan speed and power draw down to near zero, making the system more environmentally-friendly. For users with diverse needs, LucidLogix® Virtu™ GPU virtualization provides great flexibility and efficiency.

\*LucidLogix® Virtu™ supports Windows® 7 operating system.

\*\*Intel® Quick Sync Video feature is supported by 2nd generation Intel® Core™ processor family.

## **DTS Surround Sensation UltraPC**

DTS Surround Sensation UltraPC delivers exceptional 5.1 surround experience through the most common PC audio setups—your existing stereo speakers or headphones. In addition to virtual surround, “Bass enhancement” provides stronger low frequency bass sound, and “Voice clarification” provides clear human dialogue even with loud background sound. With these technologies, you may experience a better home-theater audio with ease.

## **ErP Ready**

The motherboard is European Union’s Energy-related Products (ErP) ready, and ErP requires products to meet certain energy efficiency requirements in regards to energy consumptions. This is in line with ASUS vision of creating environment-friendly and energy-efficient products through product design and innovation to reduce carbon footprint of the product and thus mitigate environmental impacts.

## 2.1 Before you proceed

Take note of the following precautions before you install motherboard components or change any motherboard settings.



- 
- Unplug the power cord from the wall socket before touching any component.
  - Before handling components, use a grounded wrist strap or touch a safely grounded object or a metal object, such as the power supply case, to avoid damaging them due to static electricity.
  - Hold components by the edges to avoid touching the ICs on them.
  - Whenever you uninstall any component, place it on a grounded antistatic pad or in the bag that came with the component.
  - Before you install or remove any component, ensure that the ATX power supply is switched off or the power cord is detached from the power supply. Failure to do so may cause severe damage to the motherboard, peripherals, or components.
-

## 2.2 Motherboard overview

### 2.2.1 Motherboard layout

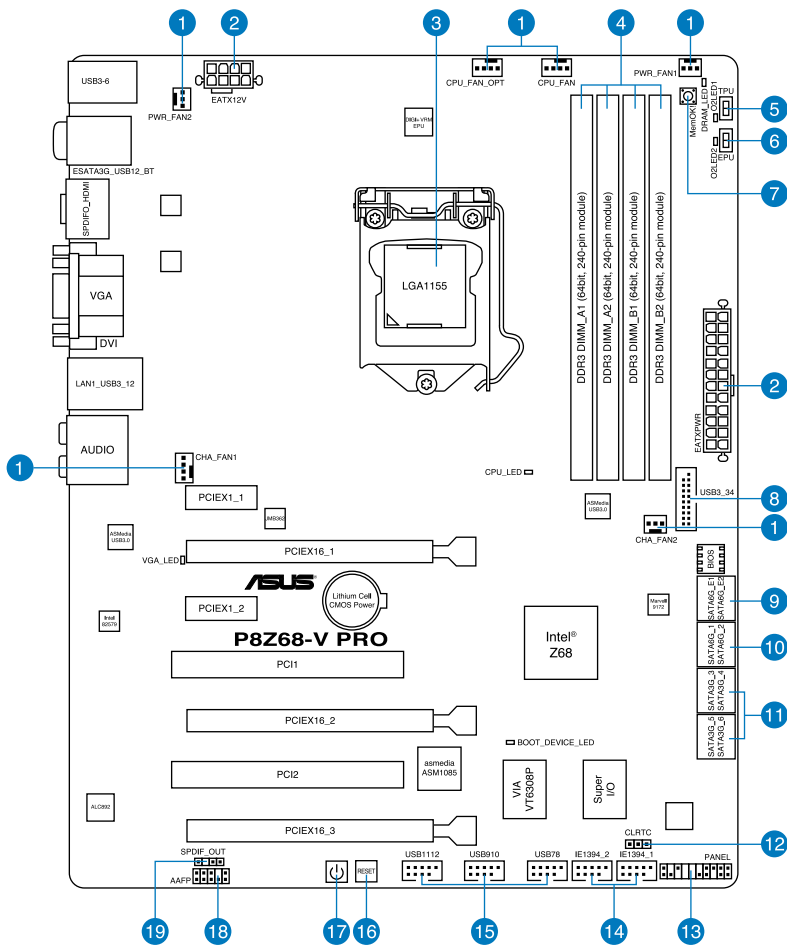

Refer to **2.2.8 Internal connectors** and **2.3.10 Rear panel connection** for more information about rear panel connectors and internal connectors.

## Layout contents

Connectors/Jumpers/Slots		Page
1.	CPU, chassis, and power fan connectors (4-pin CPU_FAN /CPU_FAN_OPT, 4-pin CHA_FAN1, 3-pin CHA_FAN2, 3-pin PWR_FAN1-2)	2-28
2.	ATX power connectors (24-pin EATXPWR, 8-pin EATX12V)	2-30
3.	LGA1155 CPU socket	2-4
4.	DDR3 DIMM slots	2-5
5.	TPU switch	2-18
6.	EPU switch	2-19
7.	MemOK! switch	2-17
8.	USB 3.0 connector (20-1 pin USB3_34)	2-25
9.	Marvell® Serial ATA 6.0 Gb/s connectors (7-pin SATA6G_E1/E2 [navy blue])	2-25
10.	Intel® Z68 Serial ATA 6.0 Gb/s connectors (7-pin SATA6G_1/2 [gray])	2-24
11.	Intel® Z68 Serial ATA 3.0 Gb/s connectors (7-pin SATA3G_3–6 [blue])	2-23
12.	Clear RTC RAM (3-pin CLRTC)	2-22
13.	System panel connector (20-8 pin PANEL)	2-31
14.	IEEE 1394a port connector (10-1 pin IE1394_1-2)	2-27
15.	USB 2.0 connectors (10-1 pin USB78, USB910, USB1112)	2-26
16.	Reset switch	2-16
17.	POWER-on switch	2-16
18.	Front panel audio connector (10-1 pin AAFP)	2-29
19.	Digital audio connector (4-1 pin SPDIF_OUT)	2-27

## 2.2.2 Central Processing Unit (CPU)

The motherboard comes with a surface mount LGA1155 socket designed for the Intel® 2nd Generation Core™ i7 / Core™ i5 / Core™ i3 Processors.

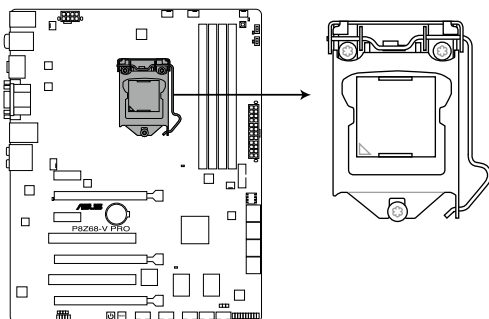

**P8Z68-V PRO CPU LGA1155**



---

Ensure that all power cables are unplugged before installing the CPU.

---



- The LGA1156 CPU is incompatible with the LGA1155 socket. DO NOT install a LGA1156 CPU on the LGA1155 socket.
  - Upon purchase of the motherboard, ensure that the PnP cap is on the socket and the socket contacts are not bent. Contact your retailer immediately if the PnP cap is missing, or if you see any damage to the PnP cap/socket contacts/motherboard components. ASUS will shoulder the cost of repair only if the damage is shipment/transit-related.
  - Keep the cap after installing the motherboard. ASUS will process Return Merchandise Authorization (RMA) requests only if the motherboard comes with the cap on the LGA1155 socket.
  - The product warranty does not cover damage to the socket contacts resulting from incorrect CPU installation/removal, or misplacement/loss/incorrect removal of the PnP cap.
-

## 2.2.3 System memory

The motherboard comes with four Double Data Rate 3 (DDR3) Dual Inline Memory Modules (DIMM) slots.



A DDR3 module is notched differently from a DDR or DDR2 module. DO NOT install a DDR or DDR2 memory module to the DDR3 slot.

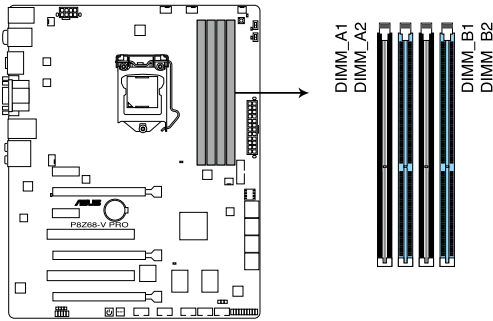

**P8Z68-V PRO 240-pin DDR3 DIMM socket**

### Recommended memory configurations

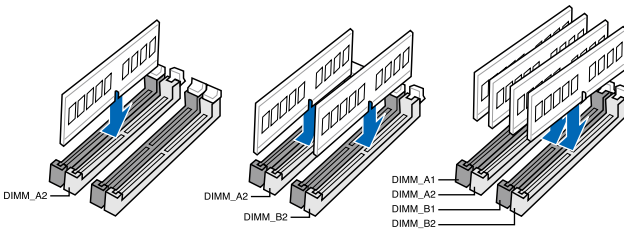

## Memory configurations

You may install 1GB, 2GB, 4GB, and 8GB unbuffered and non-ECC DDR3 DIMMs into the DIMM sockets.



- You may install varying memory sizes in Channel A and Channel B. The system maps the total size of the lower-sized channel for the dual-channel configuration. Any excess memory from the higher-sized channel is then mapped for single-channel operation.
- Due to CPU behavior, DDR3 2200/2000/1800 MHz memory module will run at DDR3 2133/1866/1600 MHz frequency as default.
- According to Intel CPU spec, DIMM voltage below 1.65V is recommended to protect the CPU.
- Always install DIMMs with the same CAS latency. For optimum compatibility, we recommend that you obtain memory modules from the same vendor.
- Due to the memory address limitation on 32-bit Windows OS, when you install 4GB or more memory on the motherboard, the actual usable memory for the OS can be about 3GB or less. For effective use of memory, we recommend that you do any of the following:
  - Use a maximum of 3GB system memory if you are using a 32-bit Windows OS.
  - Install a 64-bit Windows OS when you want to install 4GB or more on the motherboard.For more details, refer to the Microsoft® support site at <http://support.microsoft.com/kb/929605/en-us>.
- This motherboard does not support DIMMs made up of 512Mb (64MB) chips or less (Memory chip capacity counts in Megabit, 8 Megabit/Mb = 1 Megabyte/MB).



- The default memory operation frequency is dependent on its Serial Presence Detect (SPD), which is the standard way of accessing information from a memory module. Under the default state, some memory modules for overclocking may operate at a lower frequency than the vendor-marked value. To operate at the vendor-marked or at a higher frequency, refer to section **3.4 Ai Tweaker** menu for manual memory frequency adjustment.
- For system stability, use a more efficient memory cooling system to support a full memory load (4 DIMMs) or overclocking condition.



## P8Z68-V PRO Motherboard Qualified Vendors Lists (QVL) DDR3-2200 (O.C.) MHz capability

Vendors	Part No.	Size	SS/ DS	Chip Brand	Chip NO.	Timing	Voltage	DIMM socket support (Optional)		
								1 DIMM	2 DIMM	4 DIMM
G.SKILL	F3-17600CL7D-4GBFLS(XMP)	4G (2x 2G)	DS	-	-	7-10-10-28	1.65	*	*	
G.SKILL	F3-17600CL8D-4GBPS(XMP)	4GB(2 x 2GB)	DS	-	-	8-8-8-24	1.65	*	*	
G.SKILL	F3-17600CL9D-4GBTDS(XMP)	4GB(2 x 2GB)	DS	-	-	9-9-9-24	1.65	*	*	
GEIL	GET34GB2200C9DC(XMP)	4GB (2x 2GB)	DS	-	-	9-10-9-28	1.65	*	*	
KINGMAX	FLKE85F-B8KHA(XMP)	4G (2x 2G)	DS	-	-	-	1.5~1.7	*	*	
KINGMAX	FLKE85F-B8KJAA-FEIS(XMP)	4GB (2x 2GB)	DS	Kingmax	N/A	-	-	*	*	

\* The memory modules in 2200MHz and above are supported by this motherboard, however, the actual frequency support varies depending on the O.C. margin of the installed CPU.

## P8Z68-V PRO Motherboard Qualified Vendors Lists (QVL) DDR3-2133 (O.C.) MHz capability

Vendors	Part No.	Size	SS/ DS	Chip Brand	Chip NO.	Timing	Voltage	DIMM socket support (Optional)		
								1 DIMM	2 DIMM	4 DIMM
CORSAIR	CMGTX3(XMP)	2GB	DS	-	-	9-11-9-27	1.65	*	*	
G.SKILL	F3-19200CL9D-4GBPIS(XMP)	4G (2x 2G)	DS	-	-	9-11-11-31	1.65	*	*	
G.SKILL	F3-19200CL9D-4GBPIS(XMP)	4G (2x 2G)	DS	-	-	9-11-9-28	1.65	*	*	
GEIL	GET34GB2400C9DC(XMP)	4GB (2x 2GB)	DS	-	-	9-11-9-27	1.65	*	*	
Transcend	TX2400KLU-4GK (381850)(XMP)	2GB	DS	-	-	-	1.65	*	*	*
Transcend	TX2400KLU- 4GK(374243)(XMP)	2GB	DS	-	-	-	1.65	*	*	*
Patriot	PVV34G2400C9K(XMP)	4GB (2x 2GB)	DS	-	-	9-11-9-27	1.66	*	*	

\* The above QVL is for the DDR3 2400 MHz memory module. Due to CPU behavior, DDR3 2400 MHz memory module will run at DDR3 2133 MHz frequency.

Vendors	Part No.	Size	SS/ DS	Chip Brand	Chip NO.	Timing	Voltage	DIMM socket support (Optional)		
								1 DIMM	2 DIMM	4 DIMM
KINGSTON	KHX2333C9D3T1K2/4GX(XMP)	4GB (2x 2GB)	DS	-	-	-	1.65	*	*	

\* The above QVL is for the DDR3 2333 MHz memory module. Due to CPU behavior, DDR3 2333 MHz memory module will run at DDR3 2133 MHz frequency..

Vendors	Part No.	Size	SS/ DS	Chip Brand	Chip NO.	Timing	Voltage	DIMM socket support (Optional)		
								1 DIMM	2 DIMM	4 DIMM
KINGSTON	KHX2250C9D3T1K2/4GX(XMP)	4GB (2x 2GB)	DS	-	-	-	1.65	*	*	*

\* The above QVL is for the DDR3 2250 MHz memory module. Due to CPU behavior, DDR3 2250 MHz memory module will run at DDR3 2133 MHz frequency.

Vendors	Part No.	Size	SS/ DS	Chip Brand	Chip NO.	Timing	Voltage	DIMM socket support (Optional)		
								1 DIMM	2 DIMM	4 DIMM
G.SKILL	F3-17600CL7D- 4GBFLS(XMP)	4G (2x 2G)	DS	-	-	7-10-10-28	1.65	*	*	
G.SKILL	F3-17600CL8D-4GBPS(XMP)	4GB(2 x 2GB)	DS	-	-	8-8-8-24	1.65	*	*	
G.SKILL	F3-17600CL9D- 4GBTDS(XMP)	4GB(2 x 2GB)	DS	-	-	9-9-9-24	1.65	*	*	
GEIL	GET34GB2200C9DC(XMP)	4GB (2x 2GB)	DS	-	-	9-10-9-28	1.65	*	*	
KINGMAX	FLKE85F-B8KHA(XMP)	4G (2x 2G)	DS	-	-	-	1.5~1.7	*	*	
KINGMAX	FLKE85F-B8KJAA-FEIS(XMP)	4GB (2x 2GB)	DS	Kingmax	N/A	-	-	*	*	

\* The above QVL is for the DDR3 2200 MHz memory module. Due to CPU behavior, DDR3 2200 MHz memory module will run at DDR3 2133 MHz frequency.

## P8Z68-V PRO Motherboard Qualified Vendors Lists (QVL) DDR3-2133 (O.C.) MHz capability (continued)

Vendors	Part No.	Size	SS/ DS	Chip Brand	Chip NO.	Timing	Voltage	DIMM socket support (Optional)		
								1 DIMM	2 DIMM	4 DIMM
CORSAIR	CMT4GX3M2A2133C9(XMP)	4GB (2x 2GB)	DS	-	-	9-10-9-24	1.65	*	*	*
G.SKILL	F3-17066CL9D-4GBTDS(XMP)	4GB (2x 2GB)	DS	-	-	-	1.65	*	*	*
G.SKILL	F3-17066CL8D-4GBFSP(XMP)	4GB(2 x 2GB)	DS	-	-	8-8-8-24	1.65	*	*	*
G.SKILL	F3-17066CL9D-4GBTD(XMP)	4GB(2 x 2GB)	DS	-	-	9-9-9-24	1.65	*	*	*
G.SKILL	F3-17066CL9T-6GB-T	6GB(3 x 2GB)	DS	-	-	9-9-9-24	1.65	*	*	*
GEIL	GE34GB2133C9DC(XMP)	4GB(2 x 2GB)	DS	-	-	9-9-9-28	1.65	*	*	*
GEIL	GU34GB2133C9DC(XMP)	4GB(2 x 2GB)	DS	-	-	9-9-9-28	1.65	*	*	*
KINGSTON	KHX2133C9AD3T1K2/ 4GX(XMP)	4GB (2x 2GB)	DS	-	-	-	1.65	*	*	*
KINGSTON	KHX2133C9AD3W1K2/ 4GX(XMP)	4GB (2x 2GB)	DS	-	-	9	1.65	*	*	*
KINGSTON	KHX2133C9AD3X2K2/ 4GX(XMP)	4GB (2x 2GB)	DS	-	-	9	1.65	*	*	*
KINGSTON	KHX2133C9D3T1K2/ 4GX(XMP)	4GB(2 x 2GB)	DS	-	-	9	1.65	*	*	*
KINGSTON	KHX2133C9AD3T1FK4/ 8GX(XMP)	8GB (4x 2GB)	DS	-	-	9	1.65	*	*	*
Patriot	PVV34G2133C9K(XMP)	4GB (2x 2GB)	DS	-	-	9-11-9-27	1.66	*	*	*

## P8Z68-V PRO Motherboard Qualified Vendors Lists (QVL) DDR3-1866 (O.C.) MHz capability

Vendors	Part No.	Size	SS/ DS	Chip Brand	Chip NO.	Timing	Voltage	DIMM socket support (Optional)		
								1 DIMM	2 DIMM	4 DIMM
Apacer	78.AAGD5.9KD(XMP)	6GB(3 x 2GB)	DS	-	-	9-9-9-27	-	*	*	*
CORSAIR	CMT6GX3M3A2000C8(XMP)	6GB (3x 2GB)	DS	-	-	8-9-8-24	1.65	*	*	*
Crucial	BL12864BE2009.8SFB3(EPP)	1GB	SS	-	-	9-9-9-28	2	*	*	*
G.SKILL	F3-16000CL9D-4GBRH(XMP)	4GB(2 x 2GB)	DS	-	-	9-9-9-24	1.65	*	*	*
G.SKILL	F3-16000CL9D-4GBTD(XMP)	4GB(2 x 2GB)	DS	-	-	9-9-9-24	1.65	*	*	*
G.SKILL	F3-16000CL7T-6GBFSP(XMP)	6GB(3 x 2GB)	DS	-	-	7-8-7-20	1.65	*	*	*
G.SKILL	F3-16000CL9T-6GBFSP(XMP)	6GB(3 x 2GB)	DS	-	-	9-9-9-24	1.65	*	*	*
G.SKILL	F3-16000CL9T-6GBTD(XMP)	6GB(3 x 2GB)	DS	-	-	9-9-9-24	1.6	*	*	*
G.SKILL	F3-16000CL7Q-8GBFLS(XMP)	8GB(4 x 2GB)	DS	-	-	7-9-7-24	1.65	*	*	*
GEIL	GUP34GB2000C9DC(XMP)	4GB (2x 2GB)	DS	-	-	9-9-9-28	1.65	*	*	*
GEIL	GE38GB2000C9QC(XMP)	8GB(4 x 2GB)	DS	-	-	9-9-9-28	1.65	*	*	*
KINGSTON	KHX2000C9AD3T1K3/3GX(XMP)	3GB (3x 1GB)	SS	-	-	-	1.65	*	*	*
KINGSTON	KHX2000C9AD3T1K2/4GX(XMP)	4GB (2x 2GB)	DS	-	-	9	1.65	*	*	*
KINGSTON	KHX2000C9AD3W1K2/ 4GX(XMP)	4GB (2x 2GB)	DS	-	-	9	1.65	*	*	*
KINGSTON	KHX2000C9AD3T1K3/6GX(XMP)	6GB (3x 2GB)	DS	-	-	9	1.65	*	*	*
KINGSTON	KHX2000C9AD3T1K3/6GX(XMP)	6GB (3x 2GB)	DS	-	-	-	1.65	*	*	*
KINGSTON	KHX2000C9AD3W1K3/ 6GX(XMP)	6GB (3x 2GB)	DS	-	-	9	1.65	*	*	*
OCZ	OCZ3B2000LV6GK	6GB(3 x 2GB)	DS	-	-	7-8-7	1.65	*	*	*
Transcend	TX2000KLN-8GK (388375)(XMP)	4GB	DS	-	-	-	1.6	*	*	*
AEXEA	AXA3ES2G2000LG28V(XMP)	2GB	DS	-	-	-	1.65	*	*	*
AEXEA	AXA3ES4GK2000LG28V(XMP)	4GB (2x 2GB)	DS	-	-	-	1.65	*	*	*
Gingie	9CAASS37AZZ01D1	2GB	DS	-	-	9-9-9-24	-	*	*	*
Patriot	PX7312G2000ELK(XMP)	12GB (3x 4GB)	DS	-	-	9-11-9-27	1.65	*	*	*
Patriot	PVT36G2000LLK(XMP)	6GB(3 x 2GB)	DS	-	-	8-8-8-24	1.65	*	*	*
Silicon Power	SP002GBLYU200S02(XMP)	2GB	DS	-	-	-	-	*	*	*
Team	TXD32048M2000C9(XMP)	2GB	DS	Team	T3D1288RT-20	9-9-9-24	1.5	*	*	*
Team	TXD32048M2000C9-L(XMP)	2GB	DS	Team	T3D1288LT-20	9-9-9-24	1.5	*	*	*
Team	TXD32048M2000C9-L(XMP)	2GB	DS	Team	T3D1288RT-20	9-9-9-24	1.6	*	*	*

\* The above QVL is for the DDR3 2000 MHz memory module. Due to CPU behavior, DDR3 2000 MHz memory module will run at DDR3 1866 MHz frequency.

Vendors	Part No.	Size	SS/ DS	Chip Brand	Chip NO.	Timing	Voltage	DIMM socket support (Optional)		
								1 DIMM	2 DIMM	4 DIMM
CORSAIR	TR3X6G1866C9DVer4.1(XMP)	6GB(3 x 2GB)	DS	-	-	9-9-9-24	1.65	*	*	*
CORSAIR	CM28GX3M2A1866C9(XMP)	8GB ( 2x 4GB )	DS	-	-	9-10-9-27	1.5	*	*	*
G.SKILL	F3-15000CL9D-4GBRH (XMP)	4GB(2 x 2GB)	DS	-	-	9-9-9-24	1.65	*	*	*
G.SKILL	F3-15000CL9D-4GBTD(XMP)	4GB(2 x 2GB)	DS	-	-	9-9-9-24	1.65	*	*	*
KINGSTON	KHX1866C9D3T1K3/3GX(XMP)	3GB ( 3x 1GB )	SS	-	-	-	1.65	*	*	*
KINGSTON	KHX1866C9D3T1K3/6GX(XMP)	6GB(3 x 2GB)	DS	-	-	9	1.65	*	*	*
OCZ	OCZ3RPR1866C9LV3GK	3GB ( 3x 1GB )	DS	-	-	9-9-9	1.65	*	*	*
OCZ	OCZ3G1866LV4GK	4GB ( 2x 2GB )	DS	-	-	10-10-10	1.65	*	*	*
OCZ	OCZ3P1866C9LV6GK	6GB(3 x 2GB)	DS	-	-	9-9-9	1.65	*	*	*
OCZ	OCZ3RPR1866C9LV6GK	6GB(3 x 2GB)	DS	-	-	9-9-9	1.65	*	*	*
Super Talent	W1866UX2G8(XMP)	2GB(2 x 1GB)	SS	-	-	8-8-8-24	-	*	*	*
Team	TXD32048M1866C9(XMP)	2GB	DS	Team	T3D1288RT-16	9-9-9-24	1.65	*	*	*

## P8Z68-V PRO Motherboard Qualified Vendors Lists (QVL) DDR3-1600 MHz capability

Vendors	Part No.	Size	SS/ DS	Chip Brand	Chip NO.	Timing	Voltage	DIMM socket support (Optional)		
								1 DIMM	2 DIMM	4 DIMM
G.SKILL	F3-14400CL6D-4GBFLS(XMP)	4GB(2 x 2GB)	DS	-	-	6-8-6-24	1.65	*	*	*
G.SKILL	F3-14400CL9D-4GBRL(XMP)	4GB(2 x 2GB)	DS	-	-	9-9-9-24	1.6	*	*	*
KINGSTON	KHX1800C9D3T1K3/6GX(XMP)	6GB(3 x 2GB)	DS	-	-	-	1.65	*	*	*

\* The above QVL is for the DDR3 1800 MHz memory module. Due to CPU behavior, DDR3 1800 MHz memory module will run at DDR3 1600 MHz frequency.

Vendors	Part No.	Size	SS/ DS	Chip Brand	Chip NO.	Timing	Voltage	DIMM socket support (Optional)		
								1 DIMM	2 DIMM	4 DIMM
CORSAIR	CM28GX3M2A1600C8(XMP)	8GB ( 2x 4GB )	DS	-	-	8-8-8-24	1.5	*	*	*
CORSAIR	CM28GX3M2A1600C9(XMP)	8GB ( 2x 4GB )	DS	-	-	9-9-9-24	1.5	*	*	*
Crucial	BL12864BN1608.8FF(XMP)	2GB( 2x 1GB )	SS	-	-	8-8-8-24	1.65	*	*	*
Crucial	BL25664BN1608.16FF(XMP)	2GB	DS	-	-	8-8-8-24	1.65	*	*	*
G.SKILL	F3-12800CL9D-4GBNQ(XMP)	4GB ( 2x 2GB )	DS	-	-	9-9-9-24	1.5	*	*	*
G.SKILL	F3-12800CL8D-8GBECO(XMP)	8GB ( 2x4GB )	DS	-	-	8-8-8-24	1.35	*	*	*
GEIL	GUP34GB1600C7DC(XMP)	4GB ( 2x 2GB )	DS	-	-	7-7-7-24	1.6	*	*	*
GEIL	GVP38GB1600C8QC(XMP)	8GB ( 4x 2GB )	DS	-	-	8-8-8-28	1.6	*	*	*
KINGMAX	FLGD45F-B8MF7(XMP)	1GB	SS	-	-	-	-	*	*	*
KINGSTON	KHX1600C9D3X2K2/4GX(XMP)	4GB ( 2x 2GB )	DS	-	-	9	1.65	*	*	*
KINGSTON	KHX1600C9D3K3/6GX(XMP)	6GB ( 3x 2GB )	DS	-	-	9	1.65	*	*	*
OCZ	OCZ3BE1600C8LV4GK	4GB( 2x 2GB )	DS	-	-	8-8-8	1.65	*	*	*
OCZ	OCZ3OB1600LV4GK	4GB(2 x 2GB)	DS	-	-	9-9-9	1.65	*	*	*
Super Talent	WP160UX4G9(XMP)	4GB(2 x 2GB)	DS	-	-	9	-	*	*	*
Super Talent	WB160UX6G8(XMP)	6GB(3 x 2GB)	DS	-	-	8	-	*	*	*
AEXEA	AXA3PS2G1600S18V(XMP)	2GB	DS	-	-	-	1.65	*	*	*
AEXEA	AXA3PS4GK1600S18V(XMP)	4GB ( 2x 2GB )	DS	-	-	-	1.65	*	*	*
Asint	SLZ3128M8-EGJ1D(XMP)	2GB	DS	Asint	3128M8-GJ1D	-	-	*	*	*
EK Memory	EKM324L28BP8-116(XMP)	4GB( 2x 2GB )	DS	-	-	9	-	*	*	*
EK Memory	EKM324L28BP8-116(XMP)	4GB(2 x 2GB)	DS	-	-	9	-	*	*	*
Elixir	M2P2G64C8HC9N-DG(XMP)	2GB	DS	-	-	-	-	*	*	*
GoodRam	GR1600D364L9/2G	2GB	DS	GoodRam	GF1008KC-JN	-	-	*	*	*
KINGTIGER	KTG2G1600PG3(XMP)	2GB	DS	-	-	-	-	*	*	*
Mushkin	996805(XMP)	4GB ( 2x 2GB )	DS	-	-	6-8-6-24	1.65	*	*	*
Mushkin	998805(XMP)	6GB ( 3x 2GB )	DS	-	-	6-8-6-24	1.65	*	*	*
Patriot	PX7312G1600LLK(XMP)	12GB ( 3x 4GB )	DS	-	-	8-8-8-24	1.65	*	*	*
Patriot	PX538G1600LLK(XMP)	8GB ( 2x 4GB )	DS	-	-	8-8-8-24	1.65	*	*	*
Team	TXD32048M1600HC8-D(XMP)	2GB	DS	Team	T3D1288RT-16	8-8-8-24	1.65	*	*	*

## P8Z68-V PRO Motherboard Qualified Vendors Lists (QVL) DDR3-1333 MHz capability

Vendors	Part No.	Size	SS/ DS	Chip Brand	Chip NO.	Timing	Voltage	DIMM socket support (Optional)		
								1 DIMM	2 DIMM	4 DIMM
A-DATA	SU3U1333W8G9-B	8GB	DS	Elpida	J4208BASE-DJ-F	9	-	*	*	*
Apacer	78.01GC6.9L0	1GB	SS	Apacer	AM5D5808DEJSBG	9	-	*	*	*
Apacer	78.A1GC6.9L1	2GB	DS	Apacer	AM5D5808FEQSBG	9	-	*	*	*
CORSAIR	TW3X4G1333C9A	4GB (2x 2GB)	DS	-	-	9-9-9-24	1.5	*	*	*
CORSAIR	CMX8GX3M2A1333C9(XMP)	8GB (2x 4GB)	DS	-	-	9-9-9-24	1.5	*	*	*
Crucial	BL25664BN1337.16FF(XMP)	2GB	DS	-	-	7-7-7-24	1.65	*	*	*
Crucial	CT25664BA1339.16FF	2GB	DS	MICRON	D9KPT	9	-	*	*	*
ELPIDA	EBJ20UF8BCF0-DJ-F	2GB	SS	Elpida	J2108BCSE-DJ-F	-	-	*	*	*
ELPIDA	EBJ21UE8BDF0-DJ-F	2GB	DS	ELPIDA	J1108BDSSE-DJ-F	-	-	*	*	*
G.SKILL	F3-10600CL9D-4GBNT	4GB (2x 2GB)	DS	G.SKILL	D3 128M8CE9 2GB	9-9-9-24	1.5	*	*	*
G.SKILL	F3-10666CL8D-4GBHK(XMP)	4GB (2x 2GB)	DS	-	-	8-8-8-21	1.5	*	*	*
GEIL	GET316GB1333C9QC	16GB ( 4x 4GB )	DS	-	-	9-9-9-24	1.5	*	*	*
GEIL	GVP38GB1333C7QC	8GB (4x 2GB)	DS	-	-	7-7-7-24	1.5	*	*	*
Hynix	HMT325U6BFR8C-H9	2GB	SS	Hynix	H5TQ2G83BFR	-	-	*	*	*
Hynix	HMT351U6BFR8C-H9	4GB	DS	Hynix	H5TQ2G83BFR	-	-	*	*	*
KINGMAX	FLFE85F-C8KM9	2GB	SS	Kingmax	KFC8FNMXF-BXX-15A	-	-	*	*	*
KINGMAX	FLFF65F-C8KM9	4GB	DS	Kingmax	KFC8FNMXF-BXX-15A	-	-	*	*	*
Kingston	KHX1333C9D3UK2/4GX(XMP)	4GB (2x 2GB)	DS	-	-	9	1.25	*	*	*
KINGSTON	KVR1333D3N9K2/4G	4GB (2x 2GB)	DS	KINGSTON	D1288JEMFPGD9U	-	1.5	*	*	*
MICRON	M7R1JTF25664AZ-1G4D1	2GB	SS	Micron	D9L GK	-	-	*	*	*
MICRON	MT16JTF51264AZ-1G4D1	4GB	DS	Micron	D9L GK	-	-	*	*	*
OCZ	OCZ3G1333LV4GK	4GB (2x 2GB)	DS	-	-	9-9-9	1.65	*	*	*
OCZ	OCZ3G1333LV8GK	8GB (2x 4GB)	DS	-	-	9-9-9	1.65	*	*	*
PSC	PC310600U-9-10-A0	1GB	SS	PSC	A3P1GF3FGF	-	-	*	*	*
PSC	PC310600U-9-10-B0	2GB	DS	PSC	A3P1GF3FGF	-	-	*	*	*
SAMSUNG	M378B5273DH0-CH9	4GB	DS	Samsung	K4B2G08460	-	-	*	*	*
SAMSUNG	M378B1G73AH0-CH9	8GB	DS	SAMSUNG	K4B4G0846A-HCH9	-	-	*	*	*
Transcend	TS256MLK64V3N (574206)	2GB	SS	Micron	D9L GK	9	-	*	*	*
Transcend	TS512MLK64V3N (574831)	4GB	DS	Micron	D9L GK	9	-	*	*	*
ACTICA	ACT4GHU64B8H1333H	4GB	DS	Hynix	H5TQ2G83AFR	-	-	*	*	*
ACTICA	ACT4GHU72D8H1333H	4GB	DS	Hynix	H5TQ2G83AFR(ECC)	-	-	*	*	*
BUFFALO	D3U1333-2G	2GB	DS	Elpida	J1108BFBG-DJ-F	-	-	*	*	*
BUFFALO	D3U1333-4G	4GB	DS	NANYA	NT5CB256M8BN-CG	-	-	*	*	*
EK Memory	EKM324L28BP8-1H3	4GB(2 x 2GB)	DS	-	-	9	-	*	*	*
Elixir	M2F2G64CB88B7N-CG	2GB	SS	Elixir	N2CB2G808N-CG	-	-	*	*	*
Elixir	M2F4G64CB88B5N-CG	4GB	DS	Elixir	N2CB2G808N-CG	-	-	*	*	*
GoodRam	GR1333D364L9/2G	2GB	DS	Qimonda	IDSH1G-03A1F1C-13H	-	-	*	*	*
KINGTIGER	F10DA2T1680	2GB	DS	KINGTIGER	KTG1333PS1208NST-C9	-	-	*	*	*
KINGTIGER	KTG2G1333PG3	2GB	DS	-	-	-	-	*	*	*
Patriot	PSD32G13332	2GB	DS	Prriot	PM128M8D3BU-15	9	-	*	*	*
Patriot	PGS34G1333LLKA	4GB(2 x 2GB)	DS	-	-	7-7-7-20	1.7	*	*	*
Silicon Power	SP001GBLTE133S01	1GB	SS	NANYA	NT5CB128M8AN-CG	-	-	*	*	*
Silicon Power	SP002GBLTE133S01	2GB	DS	NANYA	NT5CB128M8AN-CG	-	-	*	*	*
Team	TXD31024M1333C7(XMP)	1GB	SS	Team	T3D1288LT-13	7-7-7-21	1.75	*	*	*
Team	TXD32048M1333C7-D(XMP)	2GB	DS	Team	T3D1288LT-13	7-7-7-21	1.5-1.6	*	*	*

## P8Z68-V PRO Motherboard Qualified Vendors Lists (QVL) DDR3-1066 MHz capability

Vendors	Part No.	Size	SS/ DS	Chip Brand	Chip NO.	Timing	Voltage	DIMM socket support (Optional)		
								1 DIMM	2 DIMM	4 DIMM
Crucial	CT12864BA1067.8FF	1GB	SS	MICRON	D9KPT	7	-	-	-	-
Crucial	CT12864BA1067.8SFD	1GB	SS	MICRON	D9JNL	7	-	-	-	-
Crucial	CT12872BA1067.9FF	1GB	SS	MICRON	D9KPT(ECC)	7	-	-	-	-
Crucial	CT25664BA1067.16FF	2GB	DS	MICRON	D9KPT	7	-	-	-	-
Crucial	CT25664BA1067.16SFD	2GB	DS	MICRON	D9JNL	7	-	-	-	-
Crucial	CT25672BA1067.18FF	2GB	DS	MICRON	D9KPT(ECC)	7	-	-	-	-
ELPIDA	EBJ10UE8BAW0-AE-E	1GB	SS	ELPIDA	J1108BABG-DJ-E	7	-	-	-	-
ELPIDA	EBJ10UE8EDF0-AE-F	1GB	SS	ELPIDA	J1108EDSE-DJ-F	-	-	-	-	-
ELPIDA	EBJ11UD8BAFA-AG-E	1GB	DS	ELPIDA	J5308BASE-AC-E	8	-	-	-	-
ELPIDA	EBJ21UE8BAW0-AE-E	2GB	DS	ELPIDA	J1108BABG-DJ-E	7	-	-	-	-
ELPIDA	EBJ21UE8EDF0-AE-F	2GB	DS	ELPIDA	J1108EDSE-DJ-F	-	-	-	-	-
GEIL	GG34GB1066C8DC	4GB ( 2x 2GB )	DS	GEIL	GL1L128M88BA115FW	8-8-8-20	1.3	-	-	-
Hynix	HMT112U6AFP8C-G7N0	1GB	SS	HYNIX	H5TQ1G83AFP7C	7	-	-	-	-
Hynix	HYMT112U64ZNF8-G7	1GB	SS	HYNIX	HY5TQ1G831ZNF7-G7	7	-	-	-	-
Hynix	HMT125U6AFP8C-G7N0	2GB	DS	HYNIX	H5TQ1G83AFP7C	7	-	-	-	-
Hynix	HYMT125U64ZNF8-G7	2GB	DS	HYNIX	HY5TQ1G831ZNF7-G7	7	-	-	-	-
Kingston	KVR1066D3N7/1G	1GB	SS	Kingston	D128BJPNDPLD9U	7	1.5	-	-	-
Kingston	KVR1066D3N7/2G	2GB	DS	Elpida	J1108BDSE-DJ-F	7	1.5	-	-	-
MICRON	MT8JTF12864AZ-1G1F1	1GB	SS	MICRON	8ZF22 D9KPV	7	-	-	-	-
MICRON	MT8JTF12864AZ-1G1F1	1GB	SS	MICRON	D9KPT	7	-	-	-	-
MICRON	MT9JSF12872AZ-1G1F1	1GB	SS	MICRON	D9KPT(ECC)	7	-	-	-	-
MICRON	MT16JTF25664AZ-1G1F1	2GB	DS	MICRON	8ZF22 D9KPV	7	-	-	-	-
MICRON	MT16JTF25664AZ-1G1F1	2GB	DS	MICRON	D9KPT	7	-	-	-	-
MICRON	MT18JSF25672AZ-1G1F1	2GB	DS	MICRON	D9KPT(ECC)	7	-	-	-	-
SAMSUNG	M378B5273BH1-CF8	4GB	DS	SAMSUNG	K4B2G0846B-HCF8	8	1.5	-	-	-
Elixir	M2Y2G64CB8HA9N-BE	2GB	DS	-	-	-	-	-	-	-
Elixir	M2Y2G64CB8HC5N-BE	2GB	DS	Elixir	N2CB1G80CN-BE	-	-	-	-	-
Elixir	M2Y2G64CB8HC9N-BE	2GB	DS	-	-	-	-	-	-	-
WINTEC	3DU3191A-10	1GB	DS	Qimonda	IDSH51-03A1F1C-10F	7	-	-	-	-



### Side(s): SS - Single-sided DS - Double-sided DIMM support:

- 1 DIMM: Supports one (1) module inserted into any slot as Single-channel memory configuration. **We suggest that you install the module into A2 slot.**
- 2 DIMMs: Supports two (2) modules inserted into either the blue slots or the black slots as one pair of Dual-channel memory configuration. **We suggest that you install the modules into slots A2 and B2 for better compatibility.**
- 4 DIMMs: Supports four (4) modules inserted into both the blue and black slots as two pairs of Dual-channel memory configuration.



- ASUS exclusively provides hyper DIMM support function.
- Hyper DIMM support is subject to the physical characteristics of individual CPUs. Load the X.M.P. or D.O.C.P. settings in the BIOS for the hyper DIMM support.
- Visit the ASUS website for the latest QVL.

## 2.2.4 Expansion slots



Ensure to unplug the power cord before adding or removing expansion cards. Failure to do so may cause you physical injury and damage motherboard components.

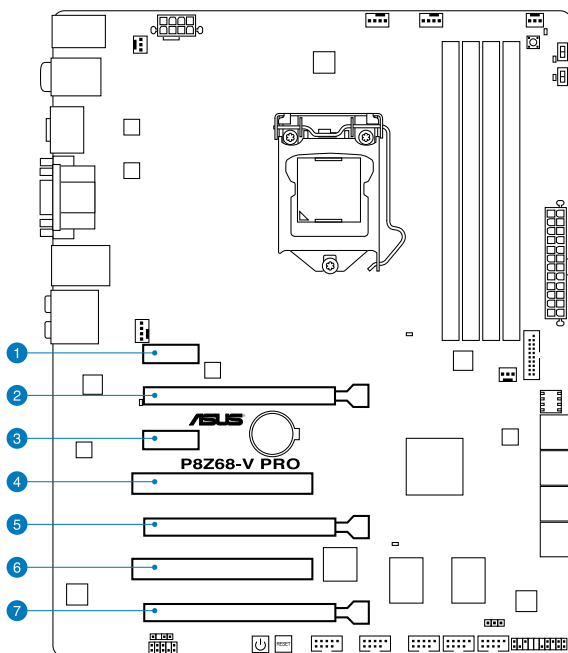

Slot No.	Slot Description
1	PCIe 2.0 x1_1 slot
2	PCIe 2.0 x16_1 slot (single at x16 or dual at x8/x8 mode)
3	PCIe 2.0 x1_2 slot
4	PCI slot 1
5	PCIe 2.0 x16_2 slot [gray] (at x8 mode)
6	PCI slot 2
7	PCIe 2.0 x16_3 slot [black] (at x4 mode, compatible with PCIe x1 and x4 devices)

VGA configuration	PCI Express operating mode	
	PCIe 2.0 x16_1	PCIe 2.0 x16_2
Single VGA/PCIe card	x16 (Recommend for single VGA)	N/A
Dual VGA/PCIe card	x8	x8



- In single VGA card mode, use the PCIe 2.0 x16\_1 slot (navy blue) for a PCI Express x16 graphics card to get better performance.
- In CrossFireX™ or SLI™ mode, use the PCIe 2.0 x16\_1 and PCIe 2.0 x16\_2 slots for PCI Express x16 graphics cards to get better performance.
- We recommend that you provide sufficient power when running CrossFireX™ or SLI™ mode. Refer to page 2-25 for details.
- Connect a chassis fan to the motherboard connector labeled CHA\_FAN1/2 when using multiple graphics cards for better thermal environment. See page 2-23 for details.

PCIEX16_3 configuration	PCI Express sharing mode				
	PCIEX16_3	PCIEX1_1	PCIEX1_2	USB3_34	ESATA
Auto Mode	X1	X1	N/A	X1	X1
X4 Mode	X4 (Recommend for high speed device)	N/A	N/A	N/A	N/A
X1 Mode	X1	X1	X1	N/A	X1

\* Please refer to 3-20 for details.

### IRQ assignments for this motherboard

	A	B	C	D	E	F	G	H
PCIEx16_1	shared	-	-	-	-	-	-	-
PCIEx16_2	shared	-	-	-	-	-	-	-
PCIEx16_3	-	shared	-	-	-	-	-	-
PCIEx1_1	-	-	shared	-	-	-	-	-
PCIEx1_2/USB3_1234	-	shared	-	-	-	-	-	-
PCI_1	-	-	shared	-	-	-	-	-
PCI_2	-	-	-	shared	-	-	-	-
LAN_1	-	-	-	-	shared	-	-	-
USB 2.0 Controller 1	-	-	-	-	-	-	-	shared
USB 2.0 Controller 2	-	-	-	-	-	-	-	shared
USB 3.0 Controller	shared							
SATA Controller	-	-	shared	-	-	-	-	-
Marvell® SATA 6G Controller	-	-	-	shared	-	-	-	-
JMicron ATA Controller	-	-	-	shared	-	-	-	-
1394 Controller	-	shared	-	-	-	-	-	-
HD Audio	-	-	-	-	-	-	shared	-
I.G.D. (Internal Graphics Device)	shared	-	-	-	-	-	-	-

## 2.2.5 Onboard switches

Onboard switches allow you to fine-tune performance when working on a bare or open-case system. This is ideal for overclockers and gamers who continually change settings to enhance system performance.

### 1. Power-on switch

The motherboard comes with a power-on switch that allows you to power up or wake up the system. The switch also lights up when the system is plugged to a power source indicating that you should shut down the system and unplug the power cable before removing or plugging in any motherboard component. The illustration below shows the location of the onboard power-on switch.

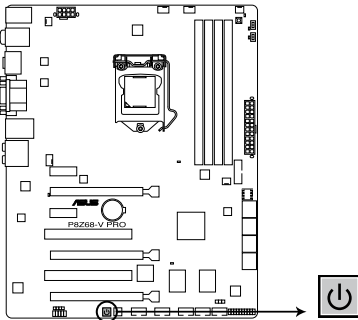

**P8Z68-V PRO Power on switch**

### 2. Reset switch

Press the reset switch to reboot the system.

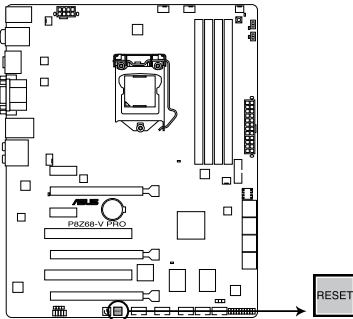

**P8Z68-V PRO Reset switch**



### 3. MemOK! switch

Installing DIMMs that are incompatible with the motherboard may cause system boot failure, and the DRAM\_LED near the MemOK! switch lights continuously. Press and hold the MemOK! switch until the DRAM\_LED starts blinking to begin automatic memory compatibility tuning for successful boot.

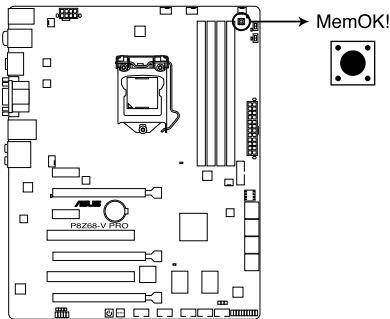

**P8Z68-V PRO MemOK! switch**



- Refer to section **2.2.6 Onboard LEDs** for the exact location of the DRAM\_LED.
- The DRAM\_LED also lights when the DIMM is not properly installed. Turn off the system and reinstall the DIMM before using the MemOK! function.
- The MemOK! switch does not function under Windows™ OS environment.
- During the tuning process, the system loads and tests failsafe memory settings. It takes about 30 seconds for the system to test one set of failsafe settings. If the test fails, the system reboots and test the next set of failsafe settings. The blinking speed of the DRAM\_LED increases, indicating different test processes.
- Due to memory tuning requirement, the system automatically reboots when each timing set is tested. If the installed DIMMs still fail to boot after the whole tuning process, the DRAM\_LED lights continuously. Replace the DIMMs with ones recommended in the Memory QVL (Qualified Vendors Lists) in this user manual or on the ASUS website at [www.asus.com](http://www.asus.com).
- If you turn off the computer and replace DIMMs during the tuning process, the system continues memory tuning after turning on the computer. To stop memory tuning, turn off the computer and unplug the power cord for about 5–10 seconds.
- If your system fail to boot due to BIOS overclocking, press the MemOK! switch to boot and load BIOS default settings. A message will appear during POST reminding you that the BIOS has been restored to its default settings.
- We recommend that you download and update to the latest BIOS version from the ASUS website at [www.asus.com](http://www.asus.com) after using the MemOK! function.

#### 4. TPU switch

Turning this switch to **Enable** will automatically optimize the system for fast, yet stable clock speeds.



For ensuring the system performance, turn the switch setting to **Enable** when the system is powered off.

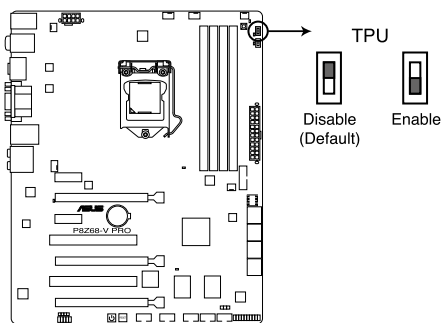

**P8Z68-V PRO TPU switch**



- The TPU LED (O2LED1) near the TPU switch lights when the switch setting is turned to **Enable**. Refer to section 2.2.6 Onboard LEDs for the exact location of the TPU LED.
- If you change the switch setting to **Enable** under the OS environment, the TPU function will be activated after the next system bootup.
- You may use the TurboV and Auto Tuning feature in the TurboV EVO application, adjust the BIOS setup program, or enable the TPU switch at the same time. However, the system will use the last setting you have made.

## 5. EPU switch

Turning this switch to **Enable** will automatically detect the current PC loadings and intelligently moderate the power consumption.



For ensuring the system performance, turn the switch setting to **Enable** when the system is powered off.

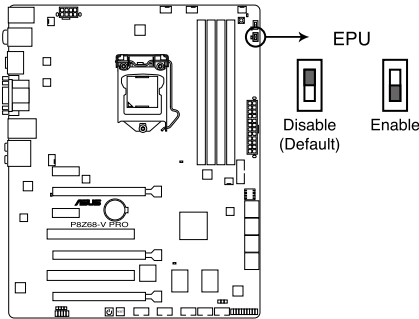

**P8Z68-V PRO EPU switch**



- The EPU LED (O2LED2) near the EPU switch lights when the switch setting is turned to **Enable**. Refer to section 2.2.6 **Onboard LEDs** for the exact location of the EPU LED.
- If you change the switch setting to **Enable** under the OS environment, the EPU function will be activated after the next system bootup.
- You may change the EPU settings in the software application or BIOS setup program, and enable the EPU function at the same time. However, the system will use the last setting you have made.

## 2.2.6 Onboard LEDs

### 1. POST State LEDs

The POST State LEDs of CPU, DRAM, VGA card, and HDD indicate key components status during POST (Power-on Self Test). If an error is found, the LED next to the error device will continue lighting until the problem is solved. This user-friendly design provides an intuitive way to locate the root problem within a second.

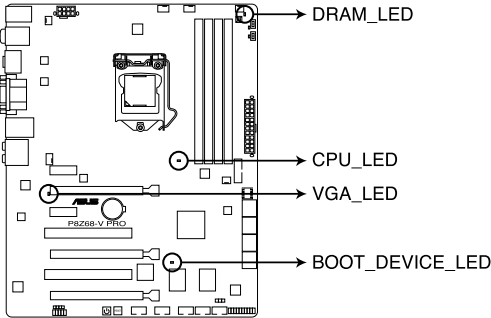

**P8Z68-V PRO CPU/ DRAM/  
BOOT\_DEVICE/ VGA LED**

### 3. TPU LED

The TPU LED lights when the TPU switch is turned to **Enable**.

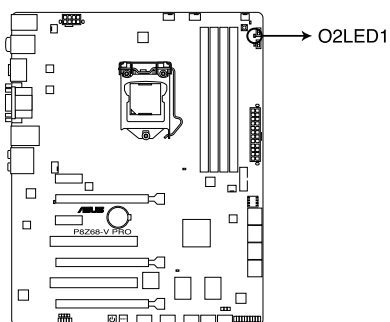

**P8Z68-V PRO TPU LED**

### 4. EPU LED

The EPU LED lights when the EPU switch is turned to **Enable**.

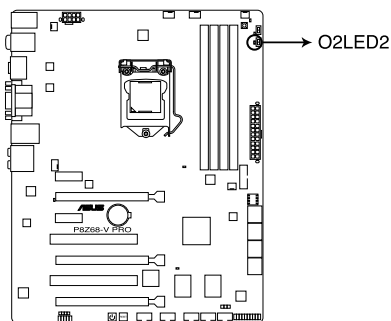

**P8Z68-V PRO EPU LED**

## 2.2.7 Jumper

### Clear RTC RAM (3-pin CLRRTC)

This jumper allows you to clear the Real Time Clock (RTC) RAM in CMOS. You can clear the CMOS memory of date, time, and system setup parameters by erasing the CMOS RTC RAM data. The onboard button cell battery powers the RAM data in CMOS, which include system setup information such as system passwords.

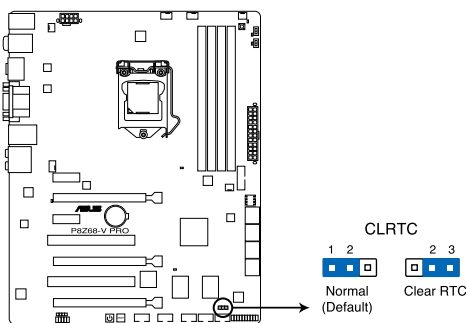

#### P8Z68-V PRO Clear RTC RAM

To erase the RTC RAM:

1. Turn OFF the computer and unplug the power cord.
2. Move the jumper cap from pins 1-2 (default) to pins 2-3. Keep the cap on pins 2-3 for about 5-10 seconds, then move the cap back to pins 1-2.
3. Plug the power cord and turn ON the computer.
4. Hold down the **<Del>** key during the boot process and enter BIOS setup to re-enter data.



Except when clearing the RTC RAM, never remove the cap on CLRRTC jumper default position. Removing the cap will cause system boot failure!



- If the steps above do not help, remove the onboard battery and move the jumper again to clear the CMOS RTC RAM data. After the CMOS clearance, reinstall the battery.
- You do not need to clear the RTC when the system hangs due to overclocking. For system failure due to overclocking, use the C.P.R. (CPU Parameter Recall) feature. Shut down and reboot the system so the BIOS can automatically reset parameter settings to default values.
- Due to the chipset behavior, AC power off is required to enable C.P.R. function. You must turn off and on the power supply or unplug and plug the power cord before rebooting the system.

## 2.2.8 Internal connectors

### 1. Intel® Z68 Serial ATA 6.0 Gb/s connectors (7-pin SATA6G\_1/2 [gray])

These connectors connect to Serial ATA 6.0 Gb/s hard disk drives via Serial ATA 6.0 Gb/s signal cables.

If you installed Serial ATA hard disk drives, you can create a RAID 0, 1, 5, and 10 configuration with the Intel® Rapid Storage Technology through the onboard Intel® Z68 chipset.

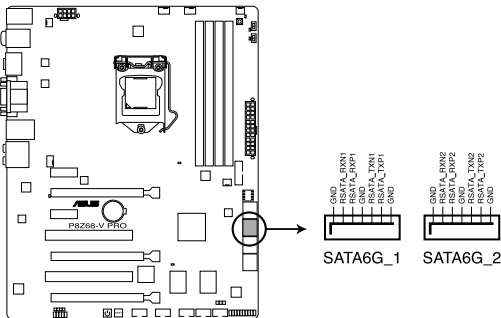

**P8Z68-V PRO Intel® SATA 6.0 Gb/s connectors**

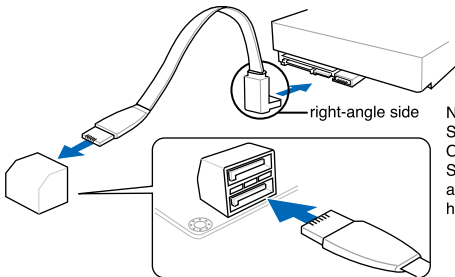

NOTE: Connect the right-angle side of SATA signal cable to SATA device. Or you may connect the right-angle side of SATA cable to the onboard SATA port to avoid mechanical conflict with huge graphics cards.



- These connectors are set to [AHCI Mode] by default. If you intend to create a Serial ATA RAID set using these connectors, set the **SATA Mode** item in the BIOS to [RAID Mode]. Refer to section 3.5.4 **SATA Configuration** for details.
- Before creating a RAID set, refer to section 4.4 **RAID configurations** or the manual bundled in the motherboard support DVD.
- When using NCQ, set the **SATA Mode** in the BIOS to [AHCI Mode]. Refer to section 3.5.4 **SATA Configuration** for details.
- You must install Windows® XP Service Pack 3 or later versions before using Serial ATA hard disk drives. The Serial ATA RAID feature is available only if you are using Windows® XP SP3 or later versions.

## 2. Intel® Z68 Serial ATA 3.0 Gb/s connectors (7-pin SATA3G\_3-6 [blue])

These connectors connect to Serial ATA 3.0 Gb/s hard disk drives and optical disc drives via Serial ATA 3.0 Gb/s signal cables.

If you installed Serial ATA hard disk drives, you can create a RAID 0, 1, 5, and 10 configuration with the Intel® Rapid Storage Technology through the onboard Intel® Z68 chipset.

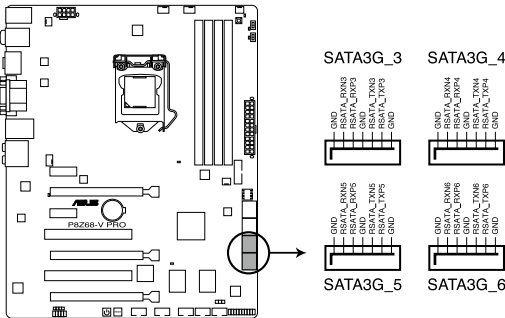

**P8Z68-V PRO Intel® SATA 3.0 Gb/s connectors**



- These connectors are set to [AHCI Mode] by default. If you intend to create a Serial ATA RAID set using these connectors, set the **SATA Mode** item in the BIOS to [RAID Mode]. Refer to section 3.5.4 **SATA Configuration** for details.
- Before creating a RAID set, refer to section 4.4 RAID configurations or the manual bundled in the motherboard support DVD.
- When using NCQ, please check the **SATA Mode** in the BIOS is [AHCI Mode]. Refer to section 3.5.4 **SATA Configuration** for details.
- You must install Windows® XP Service Pack 3 or later versions before using Serial ATA hard disk drives. The Serial ATA RAID feature is available only if you are using Windows® XP SP3 or later versions.



### 3. Marvell® Serial ATA 6.0 Gb/s connectors (7-pin SATA6G\_E1/E2 [navy blue])

These connectors connect to Serial ATA 6.0 Gb/s hard disk drives via Serial ATA 6.0 Gb/s signal cables.

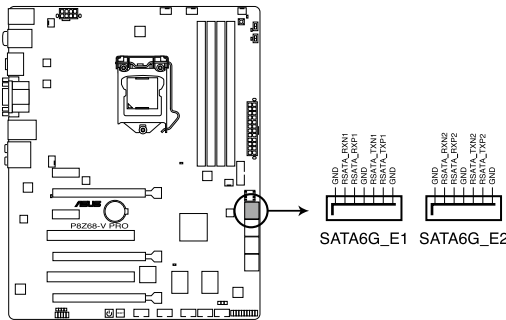

**P8Z68-V PRO Marvell® SATA 6.0 Gb/s connectors**



- The SATA6G\_E1/E2 (navy blue) connectors are for data drives only. ATAPI device is not supported.
- You must install Windows® XP Service Pack 3 or later versions before using Serial ATA hard disk drives.
- When using NCQ, set the **Marvell Storage Controller** item in the BIOS to [Enabled]. Refer to section 3.5.6 Onboard Devices Configuration for details.

### 4. USB 3.0 connector (20-1 pin USB3\_34)

These connectors are for the additional USB 3.0 ports, and complies with the USB 3.0 specification that supports up to 480 MBps connection speed. If the USB 3.0 front panel cable is available from your system chassis, with this USB 3.0 connector, you can have a front panel USB 3.0 solution.

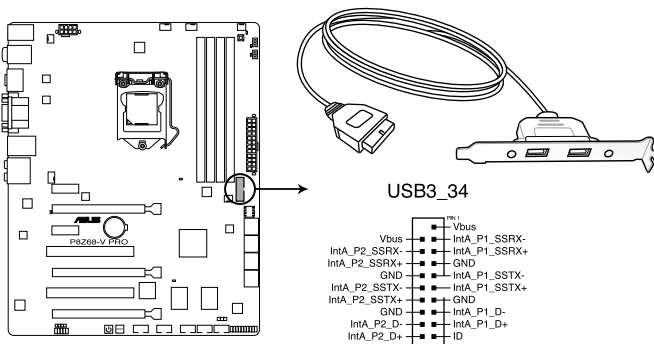

**P8Z68-V PRO USB3.0 connector**



You can connect the ASUS front panel USB 3.0 bracket to this connector to obtain the front panel USB 3.0 solution.

## 5. USB 2.0 connectors (10-1 pin USB78; USB910; USB1112)

These connectors are for USB 2.0 ports. Connect the USB module cable to any of these connectors, then install the module to a slot opening at the back of the system chassis. These USB connectors comply with USB 2.0 specification that supports up to 48 MBps connection speed.

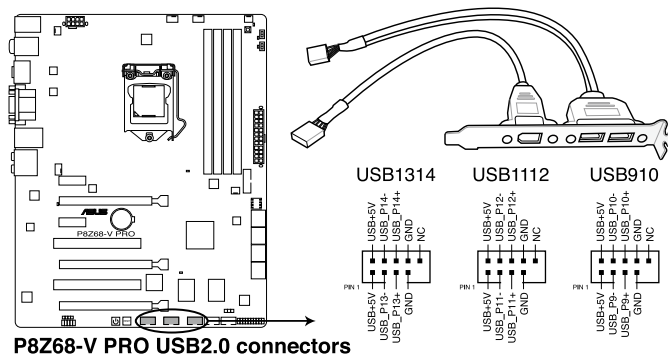

**P8Z68-V PRO USB2.0 connectors**



Never connect a 1394 cable to the USB connectors. Doing so will damage the motherboard!



You can connect the front panel USB cable to the ASUS Q-Connector (USB, blue) first, and then install the Q-Connector (USB) to the USB connector onboard if your chassis supports front panel USB ports.



The USB 2.0 module is purchased separately.

## 6. IEEE 1394a port connector (10-1 pin IE1394\_1; IE1394\_2)

These connectors are for an IEEE 1394a port. Connect the IEEE 1394a module cable to this connector, then install the module to a slot opening at the back of the system chassis.

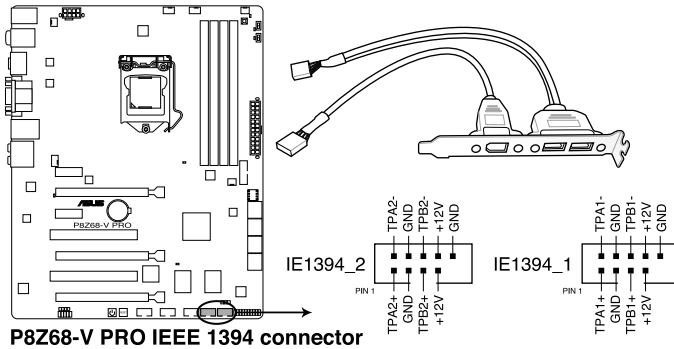

**P8Z68-V PRO IEEE 1394 connector**



Never connect a USB cable to the IEEE 1394a connector. Doing so will damage the motherboard!



The IEEE 1394a module is purchased separately.

## 7. Digital audio connector (4-1 pin SPDIF\_OUT)

This connector is for an additional Sony/Philips Digital Interface (S/PDIF) port(s). Connect the S/PDIF Out module cable to this connector, then install the module to a slot opening at the back of the system chassis.

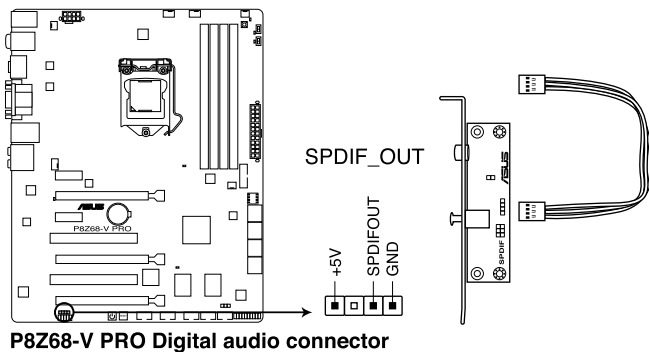

**P8Z68-V PRO Digital audio connector**



The S/PDIF module is purchased separately.

## 8. CPU, chassis, and power fan connectors (4-pin CPU\_FAN/CPU\_FAN\_OPT; 4-pin CHA\_FAN1; 3-pin CHA\_FAN2; 3-pin PWR\_FAN1/2)

Connect the fan cables to the fan connectors on the motherboard, ensuring that the black wire of each cable matches the ground pin of the connector.

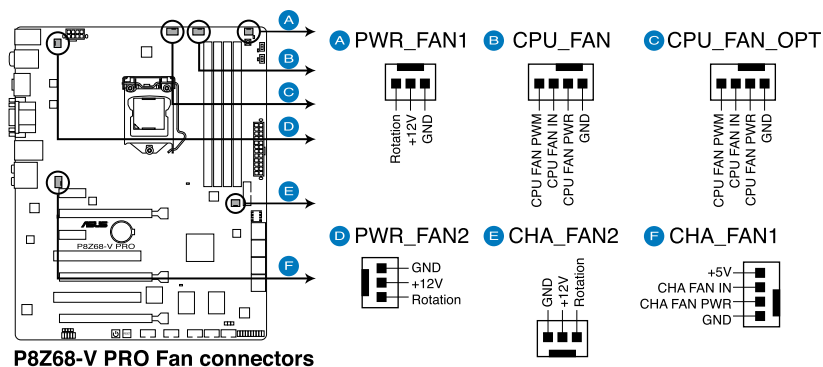

Do not forget to connect the fan cables to the fan connectors. Insufficient air flow inside the system may damage the motherboard components. These are not jumpers! Do not place jumper caps on the fan connectors!



- The CPU\_FAN connector supports the CPU fan of maximum 1A (12 W) fan power.
- Only the CPU\_FAN, CHA\_FAN 1 and CHA\_FAN 2 connectors support the ASUS FAN Xpert feature.
- If you install two VGA cards, we recommend that you plug the rear chassis fan cable to the motherboard connector labeled CHA\_FAN1 or CHA\_FAN2 for better thermal environment.

## 9. Front panel audio connector (10-1 pin AAFP)

This connector is for a chassis-mounted front panel audio I/O module that supports either HD Audio or legacy AC'97 audio standard. Connect one end of the front panel audio I/O module cable to this connector.

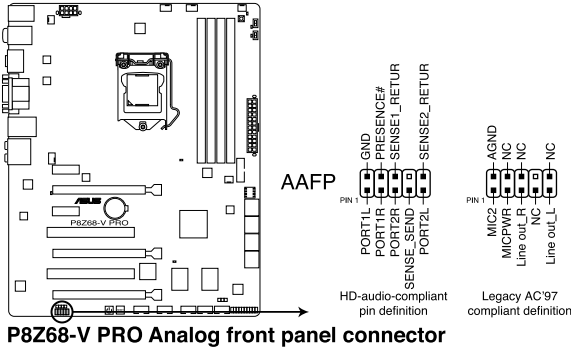

- We recommend that you connect a high-definition front panel audio module to this connector to avail of the motherboard's high-definition audio capability.
- If you want to connect a high-definition front panel audio module to this connector, set the **Front Panel Type** item in the BIOS setup to **[HD]**; if you want to connect an AC'97 front panel audio module to this connector, set the item to **[AC97]**. By default, this connector is set to **[HD]**.

## 10. ATX power connectors (24-pin EATXPWR; 8-pin EATX12V)

These connectors are for ATX power supply plugs. The power supply plugs are designed to fit these connectors in only one orientation. Find the proper orientation and push down firmly until the connectors completely fit.

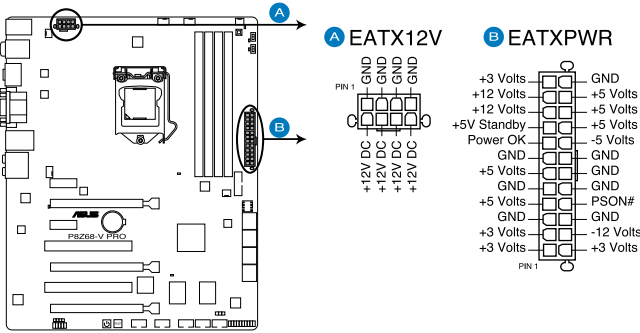

**P8Z68-V PRO ATX power connectors**



- For a fully configured system, we recommend that you use a power supply unit (PSU) that complies with ATX 12 V Specification 2.0 (or later version) and provides a minimum power of 350 W.
- Do not forget to connect the 4-pin/8-pin EATX12 V power plug; otherwise, the system will not boot.
- Use of a PSU with a higher power output is recommended when configuring a system with more power-consuming devices. The system may become unstable or may not boot up if the power is inadequate.
- If you are uncertain about the minimum power supply requirement for your system, refer to the Recommended Power Supply Wattage Calculator at <http://support.asus.com/PowerSupplyCalculator/PSCalculator.aspx?SLanguage=en-us> for details.
- If you want to use two or more high-end PCI Express x16 cards, use a PSU with 1000W power or above to ensure the system stability.

## 11. System panel connector (20-8 pin PANEL)

This connector supports several chassis-mounted functions.

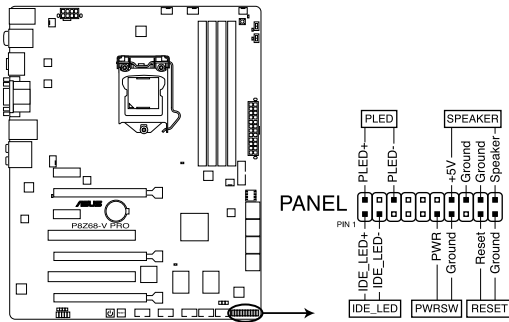

**P8Z68-V PRO System panel connector**

- **System power LED (2-pin PLED)**

This 2-pin connector is for the system power LED. Connect the chassis power LED cable to this connector. The system power LED lights up when you turn on the system power, and blinks when the system is in sleep mode.

- **Hard disk drive activity LED (2-pin IDE\_LED)**

This 2-pin connector is for the HDD Activity LED. Connect the HDD Activity LED cable to this connector. The IDE LED lights up or flashes when data is read from or written to the HDD.

- **System warning speaker (4-pin SPEAKER)**

This 4-pin connector is for the chassis-mounted system warning speaker. The speaker allows you to hear system beeps and warnings.

- **ATX power button/soft-off button (2-pin PWRSW)**





This connector is for the system power button. Pressing the power button turns the system on or puts the system in sleep or soft-off mode depending on the BIOS settings. Pressing the power switch for more than four seconds while the system is ON turns the system OFF.

- **Reset button (2-pin RESET)**

This 2-pin connector is for the chassis-mounted reset button for system reboot without turning off the system power.

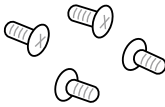
## 2.3 Building your computer system

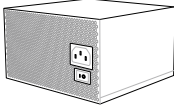
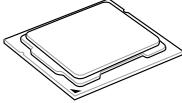
### 2.3.1 Additional tools and components to build a PC system

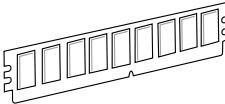
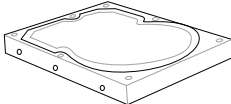
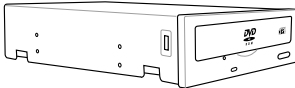
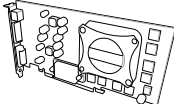
	
<b>1 bag of screws</b>	<b>Philips (cross) screwdriver</b>
	
<b>PC chassis</b>	<b>Power supply unit</b>
	
<b>Intel LGA 1155 CPU</b>	<b>Intel LGA 1155 compatible CPU Fan</b>
	
<b>DIMM</b>	<b>SATA hard disk drive</b>
	
<b>SATA optical disc drive (optional)</b>	<b>Graphics card (optional)</b>



The tools and components in the table above are not included in the motherboard package.



## 2.3.2 CPU installation



The LGA1156 CPU is incompatible with the LGA1155 socket. DO NOT install a LGA1156 CPU on the LGA1155 socket.

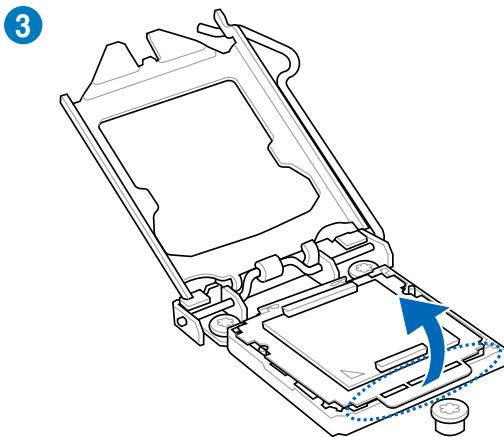
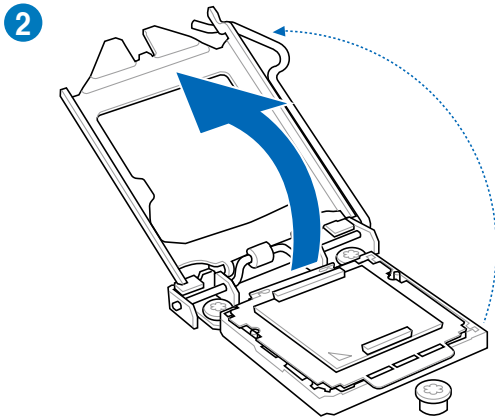
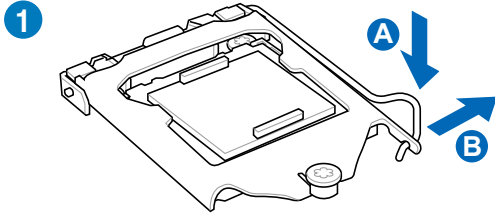

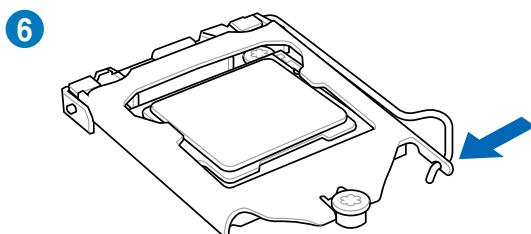
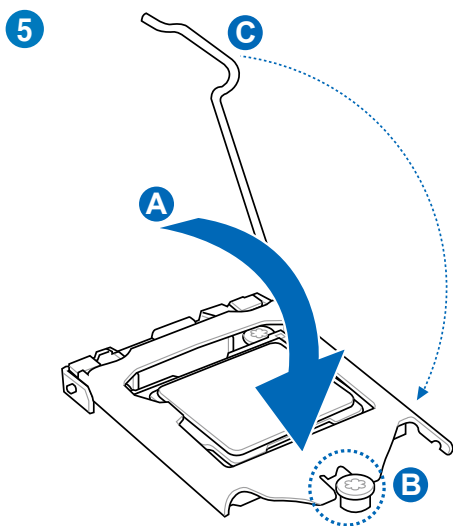
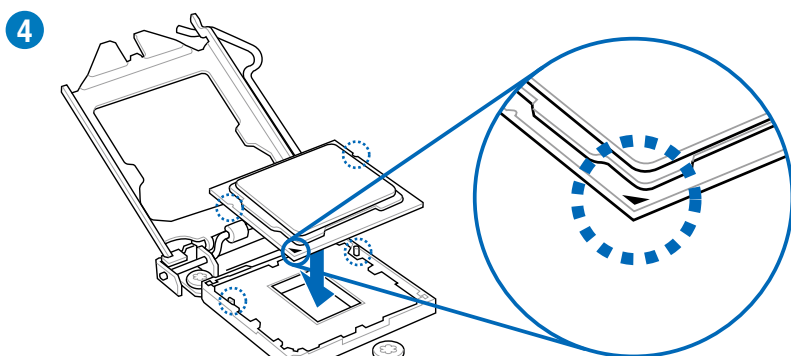

### 2.3.3 CPU heatsink and fan assembly installation

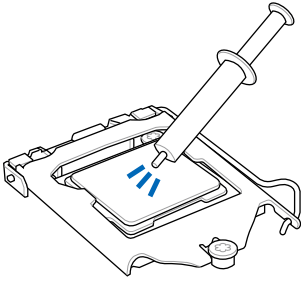

Apply the Thermal Interface Material to the CPU heatsink and CPU before you install the heatsink and fan if necessary.

To install the CPU heatsink and fan assembly

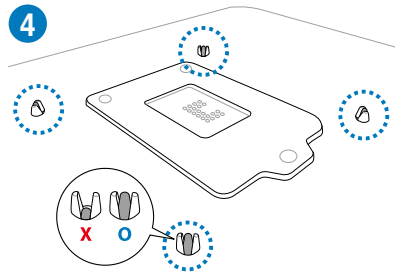
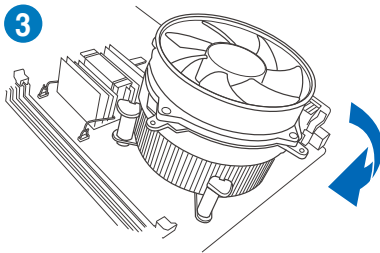
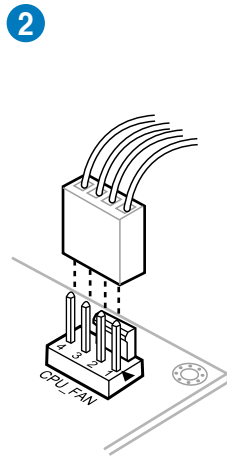
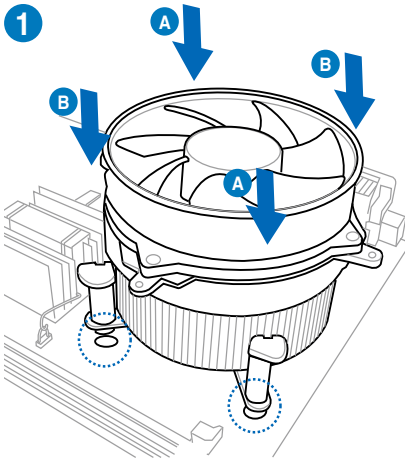

To uninstall the CPU heatsink and fan assembly

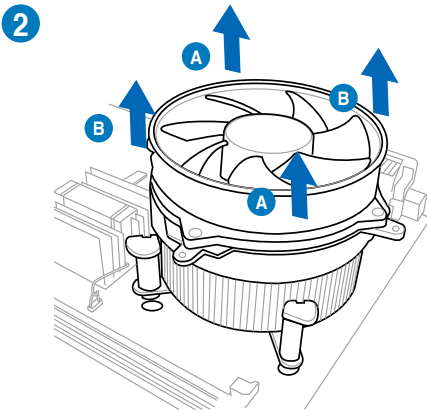
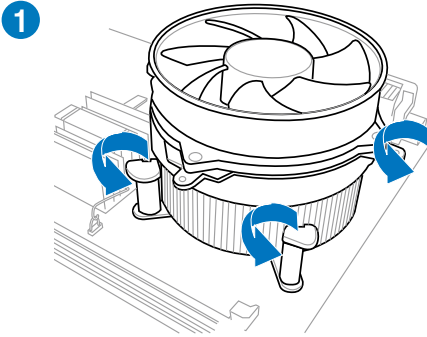

### 2.3.4 DIMM installation

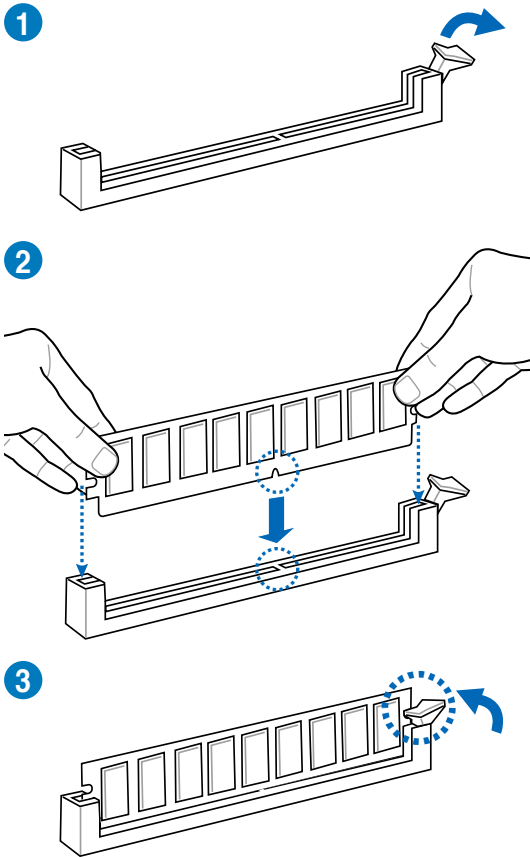

#### To remove a DIMM

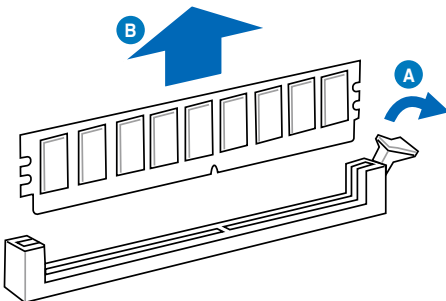

## 2.3.5 Motherboard installation



The diagrams in this section are for reference only. The motherboard layout may vary with models, but the installation steps remain the same.

1

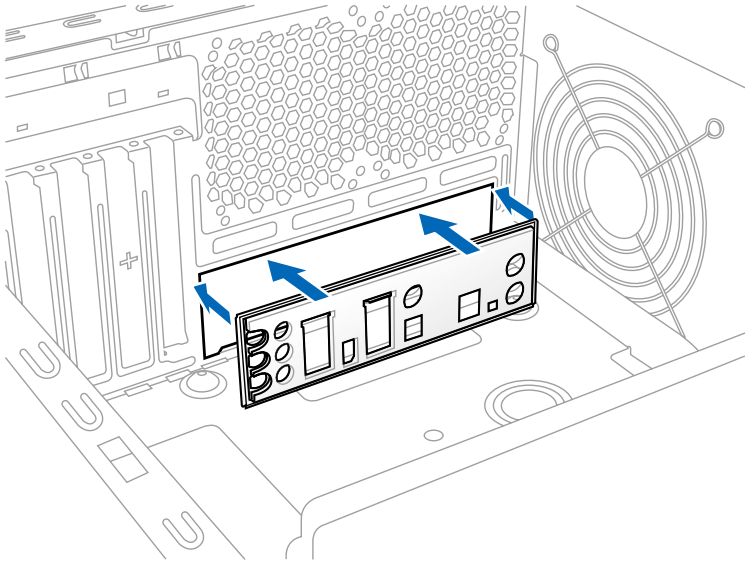

2

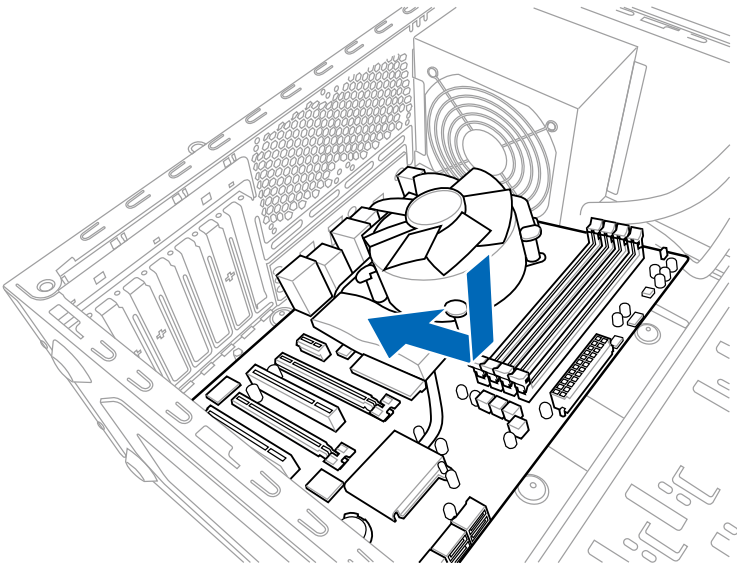

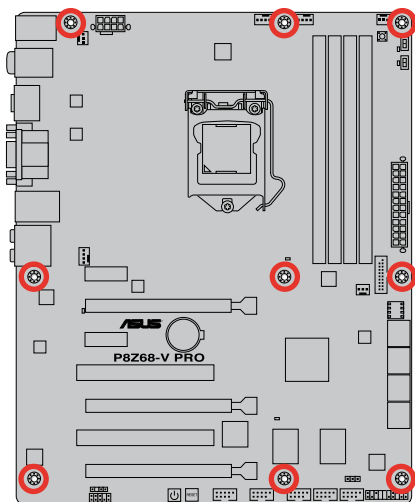
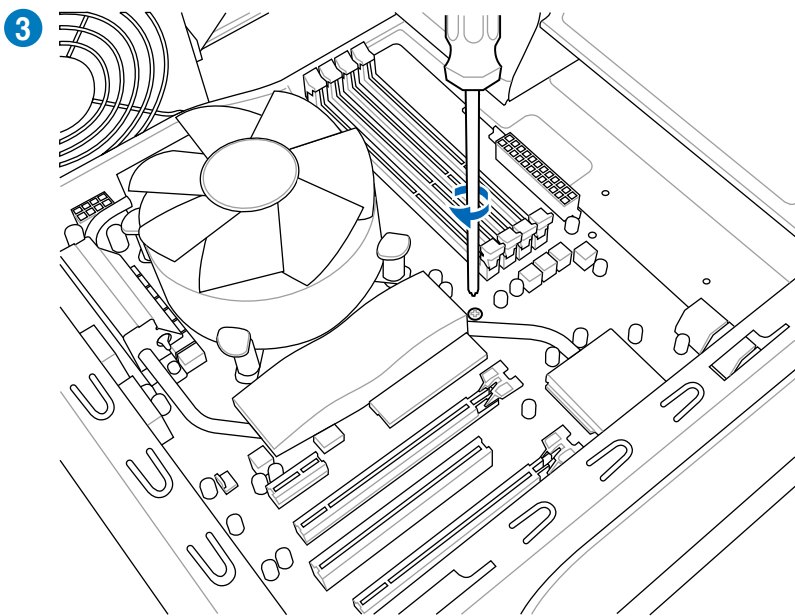

DO NOT overtighten the screws! Doing so can damage the motherboard.

### 2.3.6 ATX Power connection

1

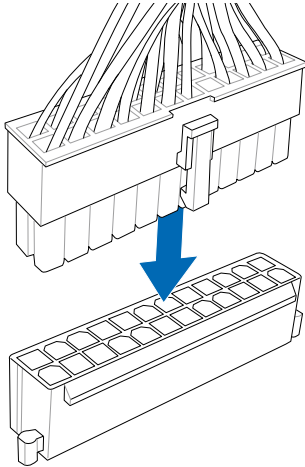

2

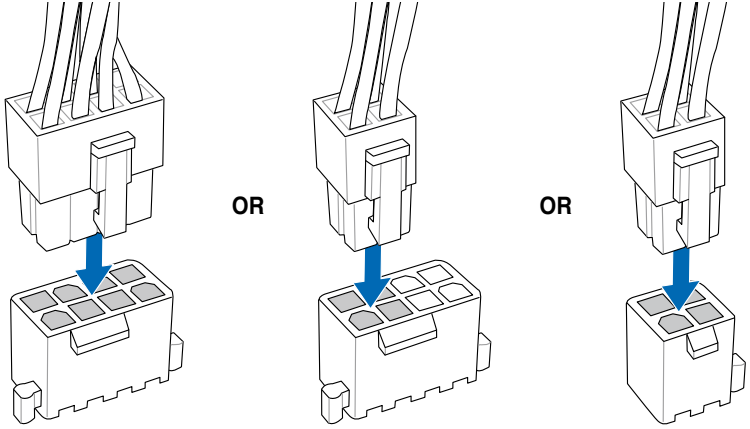



### 2.3.7 SATA device connection

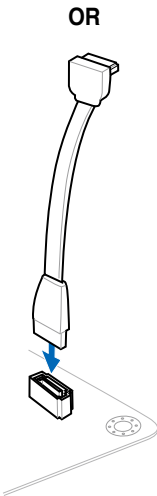
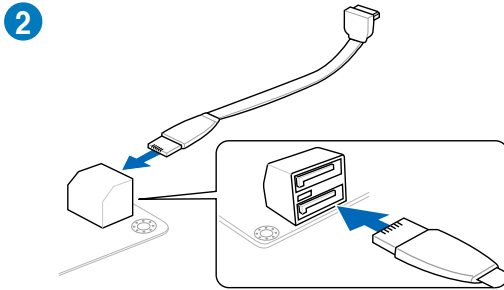
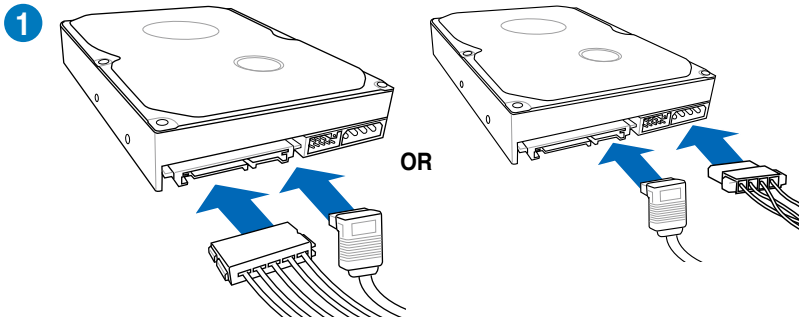

## 2.3.8 Front I/O Connector

### To install ASUS Q-Connector

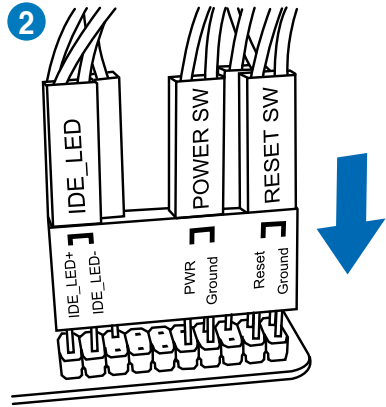
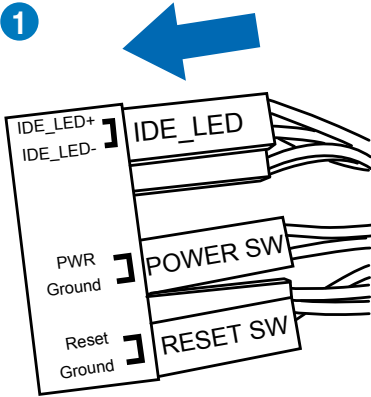

### To install USB 2.0 Connector

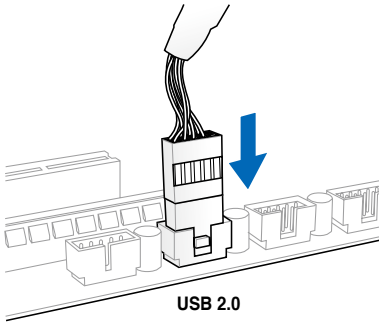

### To install front panel audio connector

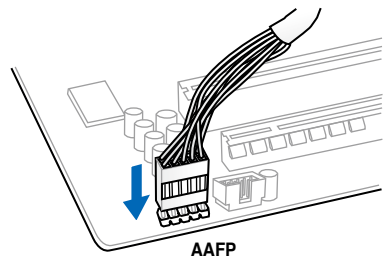

### To install USB 3.0 Connector

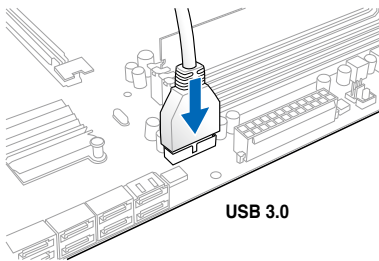

## 2.3.9 Expansion Card installation

To install PCIe x16 cards

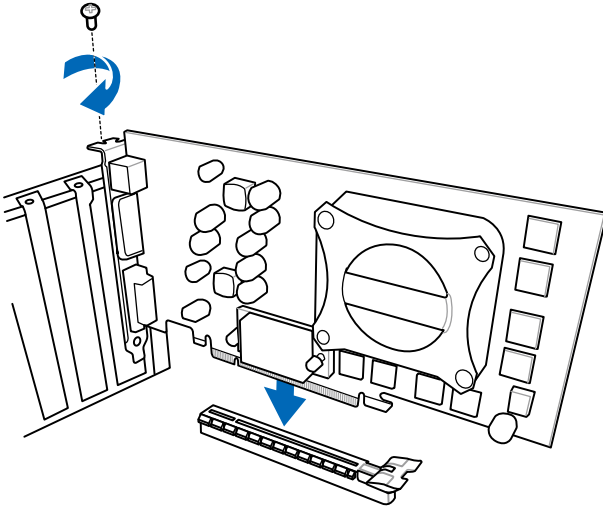

To install PCIe x1 cards

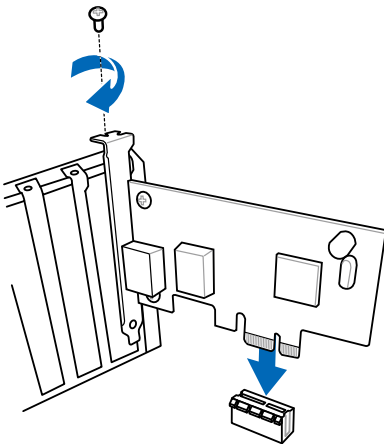

To install PCI cards

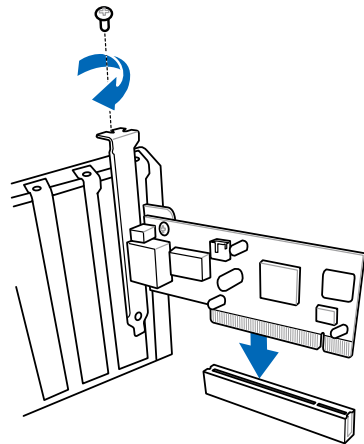

## 2.3.10 Rear panel connection

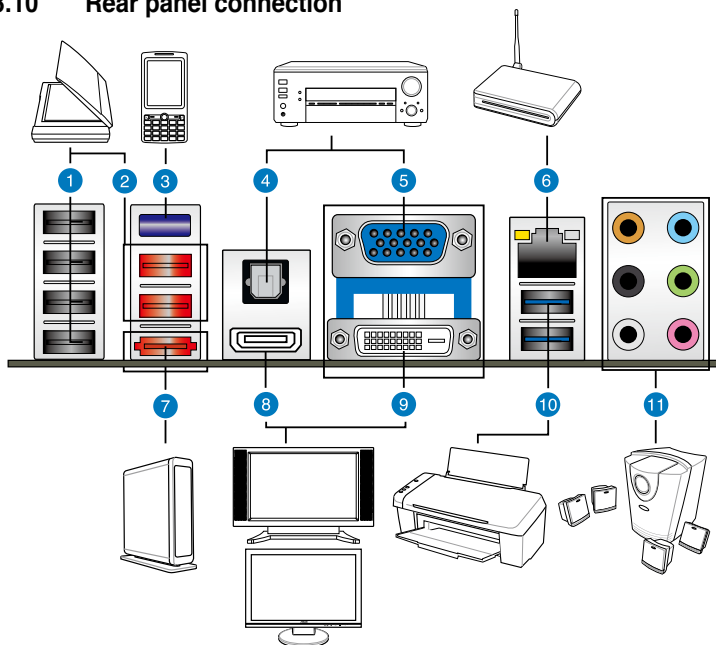

### Rear panel connectors

1. USB 2.0 ports 3, 4, 5 and 6	7. External SATA port
2. USB 2.0 ports 1 and 2	8. HDMI port
3. Bluetooth module*	9. DVI port
4. Optical S/PDIF Out port	10. USB 3.0 ports 1 and 2
5. VGA port	11. Audio I/O ports***
6. Intel LAN (RJ-45) port 1**	

\*, \*\* and \*\*\*: Refer to the tables on the next page for bluetooth module LED, LAN port LED, and audio port definitions.



- DO NOT insert a different connector to the external SATA port.
- Due to USB 3.0 controller limitation, USB 3.0 devices can only be used under Windows® OS environment and after the USB 3.0 driver installation.
- USB 3.0 devices can only be used as data storage only.
- We strongly recommend that you connect USB 3.0 devices to USB 3.0 ports for faster and better performance for your USB 3.0 devices.
- If you want to use the hot-plug function of the external SATA ports, you have to set the **JMB Storage Controller** item in the BIOS setting to [Enabled] and install the **JMicron JMB36X Controller Driver** from the motherboard support DVD. Refer to section **3.5.6 Onboard Devices Configuration** for details.

## \* Bluetooth dongle LED indications

Activity Link LED	
Status	Description
OFF	No link
Blue	Linked
BLINKING	Data activity

## \*\* LAN port LED indications

Activity Link LED		Speed LED	
Status	Description	Status	Description
OFF	No link	OFF	10 Mbps connection
ORANGE	Linked	ORANGE	100 Mbps connection
BLINKING	Data activity	GREEN	1 Gbps connection

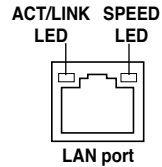

- If you use an Intel® CPU with integrated GPU and install an add-on VGA card on your motherboard, the system will automatically select the the add-on VGA card as the primary VGA output after reboot. To use the iGPU as the VGA output, go to **3.5.3 System Agent Configuration > Initiate Graphic Adapter**, select **[iGPU]**, and plug the VGA cable(s) to the onboard video port(s) for VGA output.
- This motherboard comes with multiple VGA output that features desktop extension on two monitors. You can connect two monitors to any two of the onboard VGA, DVI-D, and HDMI ports. Note that DVI-D/HDMI dual output works in OS environment only and that during POST or BIOS setup, only DVI-D output is valid.
- Due to the Intel® VGA driver issue, the Windows® Display Settings menu may offer some resolution options that your monitor does not support. When you set a resolution not supported by your monitor, it will black out. If this happens, wait 15 seconds for the system to return to its original setting or restart the system and press F8 to enter Safe Mode. In Safe Mode, change the display setting to 800 x 600, and then restart the system to adjust the monitor resolution from the Windows® Display Settings menu.
- Due to the Intel® driver issue, some monitor resolution settings will lead to monitor overscan or underscan. Refer to the next page for the troubleshooting on monitor overscan/underscan problem
- **Playback of Blu-Ray Discs**  
The speed and bandwidth of the CPU/Memory, DVD player, and drivers will affect the playback quality. Following is a configuration example for your reference. Using the CPU/Memory of higher speed and bandwidth with the higher-version DVD player and drivers will upgrade the playback quality.  
**CPU: Intel Pentium 2.8GHz**  
**DIMM: DDR3-1066 2GB**  
**Playback software - CyberLink PowerDVD v9.0 Ultra Build 2320**
- To play Blu-Ray Disc, make sure to use an HDCP compliant monitor.
- You can only play Blu-Ray Disc under Windows® Vista™ / 7™ OS.

## \*\*Troubleshooting on monitor overscan / underscan problem

1. Install **Intel Graphics Accelerator Driver** from the motherboard support DVD.
2. From the Windows® notification area, double-click the **Intel(R) Graphics Media Accelerator Driver** icon and click **Graphics Properties**.



3. Click **Display > General Settings** and select a **Resolution**. Click **Apply**.



4. Or you can click **Display > General Settings > Scaling > Customize Aspect Ratio**. Move the **Horizontal Scaling** and **Vertical Scaling** sliders and then click **Apply**.



**\*\*\*Audio 2, 4, 6, or 8-channel configuration**

Port	Headset 2-channel	4-channel	6-channel	8-channel
Light Blue	Line In	Line In	Line In	Line In
Lime	Line Out	Front Speaker Out	Front Speaker Out	Front Speaker Out
Pink	Mic In	Mic In	Mic In	Mic In
Orange	–	–	Center/Subwoofer	Center/Subwoofer
Black	–	Rear Speaker Out	Rear Speaker Out	Rear Speaker Out
Gray	–	–	–	Side Speaker Out

**2.3.11 Audio I/O connections**

**Audio I/O ports**

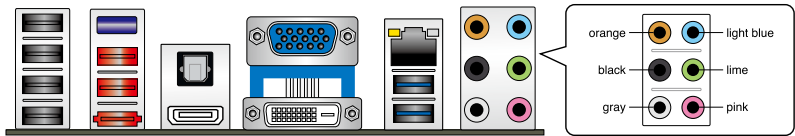

**Connect to Headphone and Mic**

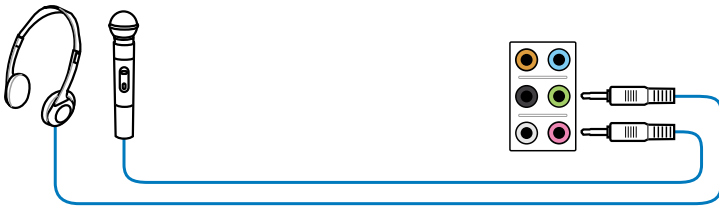

### Connect to Stereo Speakers

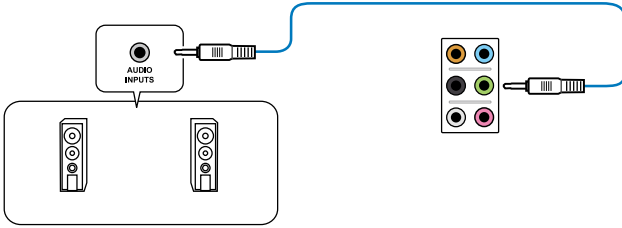

### Connect to 2.1 channel Speakers

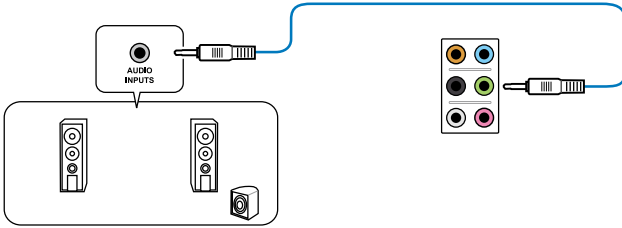

### Connect to 4.1 channel Speakers

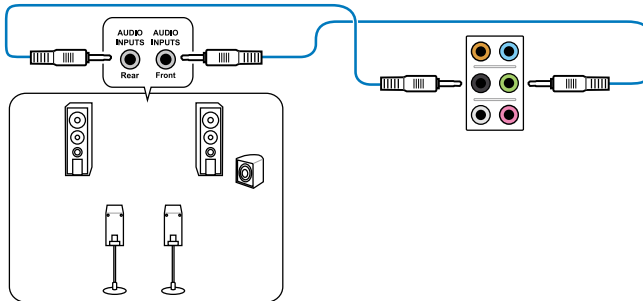



## Connect to 5.1 channel Speakers

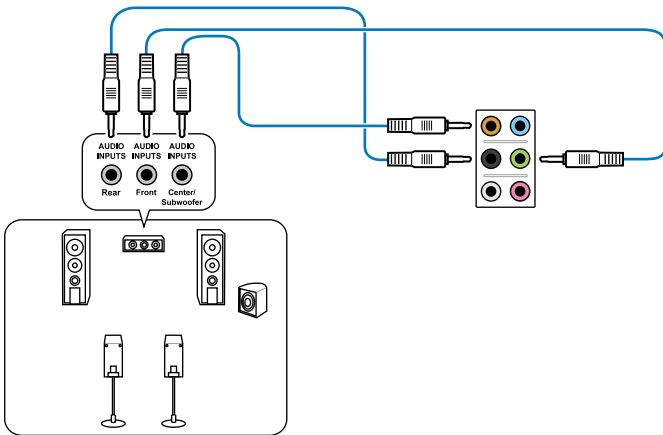

## Connect to 7.1 channel Speakers

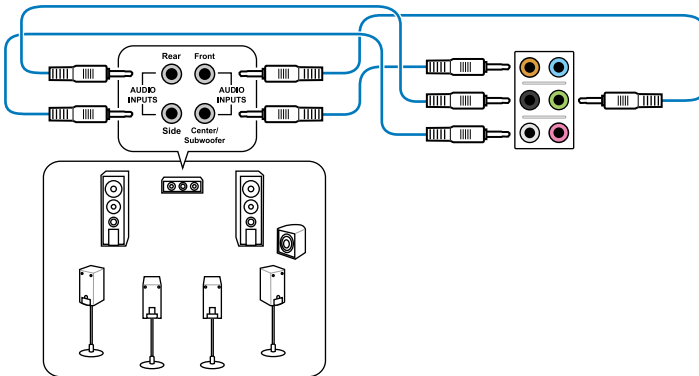

When the DTS Surround Sensation UltraPC function is enabled, ensure to connect the rear speaker to the gray port.

## 2.4 Starting up for the first time

1. After making all the connections, replace the system case cover.
2. Be sure that all switches are off.
3. Connect the power cord to the power connector at the back of the system chassis.
4. Connect the power cord to a power outlet that is equipped with a surge protector.
5. Turn on the devices in the following order:
  - a. Monitor
  - b. External SCSI devices (starting with the last device on the chain)
  - c. System power
6. After applying power, the system power LED on the system front panel case lights up. For systems with ATX power supplies, the system LED lights up when you press the ATX power button. If your monitor complies with the “green” standards or if it has a “power standby” feature, the monitor LED may light up or change from orange to green after the system LED turns on.

The system then runs the power-on self tests or POST. While the tests are running, the BIOS beeps (refer to the BIOS beep codes table below) or additional messages appear on the screen. If you do not see anything within 30 seconds from the time you turned on the power, the system may have failed a power-on test. Check the jumper settings and connections or call your retailer for assistance.

BIOS Beep	Description
One short beep	VGA detected Quick boot set to disabled No keyboard detected
One continuous beep followed by two short beeps then a pause (repeated)	No memory detected
One continuous beep followed by three short beeps	No VGA detected
One continuous beep followed by four short beeps	Hardware component failure

7. At power on, hold down the <Delete> key to enter the BIOS Setup. Follow the instructions in Chapter 3.

## 2.5 Turning off the computer

While the system is ON, pressing the power switch for less than four seconds puts the system on sleep mode or soft-off mode, depending on the BIOS setting. Pressing the power switch for more than four seconds lets the system enter the soft-off mode regardless of the BIOS setting.

# Chapter 3

## 3.1 Knowing BIOS



The ASUS UEFI BIOS offers a user-friendly interface that goes beyond traditional keyboard-only BIOS controls to enable more flexible and convenient mouse input. Users can easily navigate the UEFI BIOS with the same smoothness as their operating system. The term “BIOS” in this user manual refers to “UEFI BIOS” unless otherwise specified.

BIOS (Basic Input and Output System) stores system hardware settings such as storage device configuration, overclocking settings, advanced power management, and boot device configuration that are needed for system startup in the motherboard CMOS. In normal circumstances, the default BIOS settings apply to most conditions to ensure optimum performance. **We recommend that you not change the default BIOS settings** except in the following circumstances:

- An error message appears on the screen during the system bootup and requests you to run the BIOS Setup.
- You have installed a new system component that requires further BIOS settings or update.



Inappropriate settings of the BIOS may result to instability or failure to boot. **We strongly recommend that you change the BIOS settings only with the help of a trained service personnel.**

## 3.2 BIOS setup program

A BIOS setup program is provided for BIOS item modification. When you start up the computer, the system provides you with the opportunity to run this program. Press <Del> during the Power-On Self-Test (POST) to enter the Setup utility. Otherwise, POST continues with its test routines.

If you wish to enter Setup after POST, press <Ctrl> + <Alt> + <Delete>, or press the reset button on the system chassis to restart the system. You can also turn the system off and then turn it back on to restart the system. Do this last option only if the first two failed.



- The BIOS setup screens shown in this section are for reference purposes only, and may not exactly match what you see on your screen.
- Ensure that a USB mouse is connected to your motherboard if you want to use the mouse to control the BIOS setup program.
- If the system becomes unstable after changing any BIOS setting, load the default settings to ensure system compatibility and stability. Select the **Load Optimized Defaults** item under the **Exit** menu. See section **3.9 Exit Menu** for details.
- If the system fails to boot after changing any BIOS setting, try to clear the CMOS and reset the motherboard to the default value. See section **2.2.8 Jumper** for information on how to erase the RTC RAM.
- The BIOS setup program does not support the bluetooth devices.

The BIOS setup program is designed to make it as easy to use as possible. Being a menu-driven program, it lets you scroll through the various submenus and select from the available options using a keyboard or a USB mouse.

The BIOS setup program can be used under two modes: **EZ Mode** and **Advanced Mode**. You can change modes from the **Exit** menu or from the **Exit/Advanced Mode** button in the **EZ Mode/Advanced Mode** screen.

### 3.2.1 EZ Mode

By default, the EZ Mode screen appears when you enter the BIOS setup program. The EZ Mode provides you an overview of the basic system information, and allows you to select the display language, system performance mode and boot device priority. To access the Advanced Mode, click **Exit/Advanced Mode**, then select **Advanced Mode**.



The default screen for entering the BIOS setup program can be changed. Refer to the **Setup Mode** item in section 3.7 **Boot menu** for details.

**Displays the CPU/motherboard temperature, CPU/5V/3.3V/12V voltage output, CPU/chassis/power fan speed**

**Selects the display language of the BIOS setup program**

**Clicks to display all fan speeds if available**

**Exits the BIOS setup program without saving the changes, saves the changes and resets the system, or enters the Advanced Mode**

**Selects the boot device priority**

**Displays the system properties of the selected mode on the right hand side**

**Power Saving mode**

**Normal mode**

**Selects the boot device priority**

**Loads optimized default**

**ASUS Optimal mode**



- The boot device options vary depending on the devices you installed to the system.
- The **Boot Menu(F8)** button is available only when the boot device is installed to the system.

### 3.2.2 Advanced Mode

The Advanced Mode provides advanced options for experienced end-users to configure the BIOS settings. The figure below shows an example of the Advanced Mode. Refer to the following sections for the detailed configurations.



To access the Advanced Mode, click **Exit**, then select **Advanced Mode**.



#### Menu bar

The menu bar on top of the screen has the following main items:

<b>Main</b>	For changing the basic system configuration
<b>Ai Tweaker</b>	For changing the overclocking settings
<b>Advanced</b>	For changing the advanced system settings
<b>Monitor</b>	For displaying the system temperature, power status, and changing the fan settings.
<b>Boot</b>	For changing the system boot configuration
<b>Tool</b>	For configuring options for special functions
<b>Exit</b>	For selecting the exit options and loading default settings

## Menu items

The highlighted item on the menu bar displays the specific items for that menu. For example, selecting **Main** shows the Main menu items.

The other items (Ai Tweaker, Advanced, Monitor, Boot, Tool, and Exit) on the menu bar have their respective menu items.

## Back button

This button appears when entering a submenu. Press <Esc> or use the USB mouse to click this button to return to the previous menu screen.

## Submenu items

A greater than sign (>) before each item on any menu screen means that the item has a submenu. To display the submenu, select the item and press <Enter>.

## Pop-up window

Select a menu item and press <Enter> to display a pop-up window with the configuration options for that item.

## Scroll bar

A scroll bar appears on the right side of a menu screen when there are items that do not fit on the screen. Press the Up/Down arrow keys or <Page Up> / <Page Down> keys to display the other items on the screen.

## Navigation keys

At the bottom right corner of the menu screen are the navigation keys for the BIOS setup program. Use the navigation keys to select items in the menu and change the settings.

## General help

At the top right corner of the menu screen is a brief description of the selected item. Use <F12> key to capture the BIOS screen and save it to the removable storage device.

## Configuration fields

These fields show the values for the menu items. If an item is user-configurable, you can change the value of the field opposite the item. You cannot select an item that is not user-configurable.

A configurable field is highlighted when selected. To change the value of a field, select it and press <Enter> to display a list of options.

### 3.3 Main menu

The Main menu screen appears when you enter the Advanced Mode of the BIOS Setup program. The Main menu provides you an overview of the basic system information, and allows you to set the system date, time, language, and security settings.

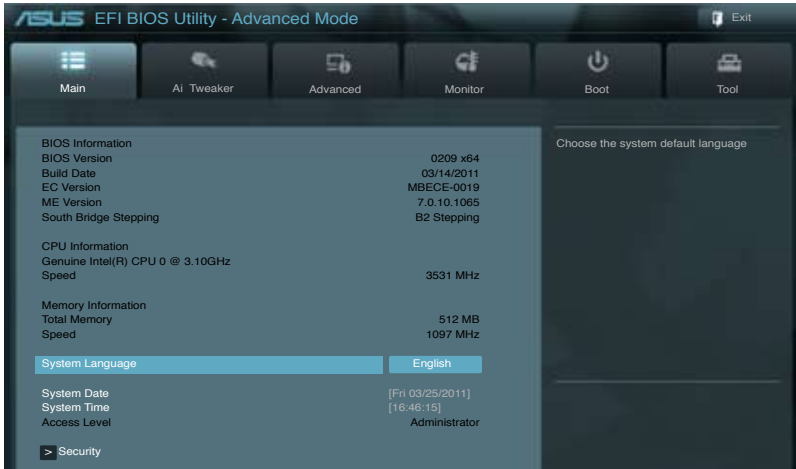

### Security

The Security menu items allow you to change the system security settings.

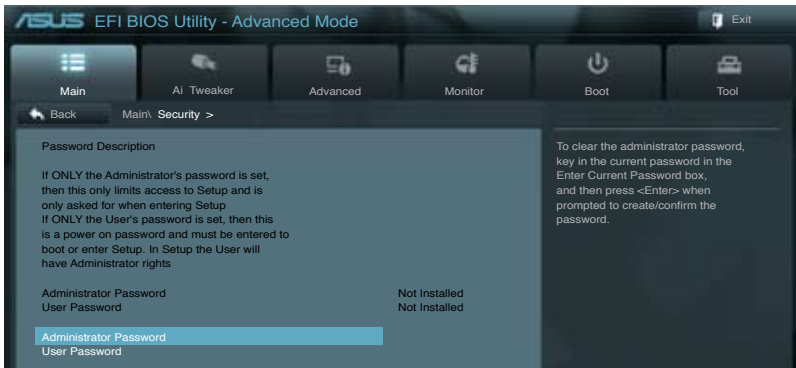

- If you have forgotten your BIOS password, erase the CMOS Real Time Clock (RTC) RAM to clear the BIOS password. See section 2.3.7 **Jumper** for information on how to erase the RTC RAM.
- The **Administrator** or **User Password** items on top of the screen show the default **Not Installed**. After you set a password, these items show **Installed**.

## Administrator Password

If you have set an administrator password, we recommend that you enter the administrator password for accessing the system. Otherwise, you might be able to see or change only selected fields in the BIOS setup program.

To set an administrator password:

1. Select the **Administrator Password** item and press <Enter>.
2. From the **Create New Password** box, key in a password, then press <Enter>.
3. Confirm the password when prompted.

To change an administrator password:

1. Select the **Administrator Password** item and press <Enter>.
2. From the **Enter Current Password** box, key in the current password, then press <Enter>.
3. From the **Create New Password** box, key in a new password, then press <Enter>.
4. Confirm the password when prompted.

To clear the administrator password, follow the same steps as in changing an administrator password, but press <Enter> when prompted to create/confirm the password. After you clear the password, the **Administrator Password** item on top of the screen shows **Not Installed**.

## User Password

If you have set a user password, you must enter the user password for accessing the system. The **User Password** item on top of the screen shows the default **Not Installed**. After you set a password, this item shows **Installed**.

To set a user password:

1. Select the **User Password** item and press <Enter>.
2. From the **Create New Password** box, key in a password, then press <Enter>.
3. Confirm the password when prompted.

To change a user password:

1. Select the **User Password** item and press <Enter>.
2. From the **Enter Current Password** box, key in the current password, then press <Enter>.
3. From the **Create New Password** box, key in a new password, then press <Enter>.
4. Confirm the password when prompted.

To clear the user password, follow the same steps as in changing a user password, but press <Enter> when prompted to create/confirm the password. After you clear the password, the **User Password** item on top of the screen shows **Not Installed**.



## 3.4 Ai Tweaker menu

The Ai Tweaker menu items allow you to configure overclocking-related items.



Be cautious when changing the settings of the Ai Tweaker menu items. Incorrect field values can cause the system to malfunction.



The configuration options for this section vary depending on the CPU and DIMM model you installed on the motherboard.



Scroll down to display the following items:

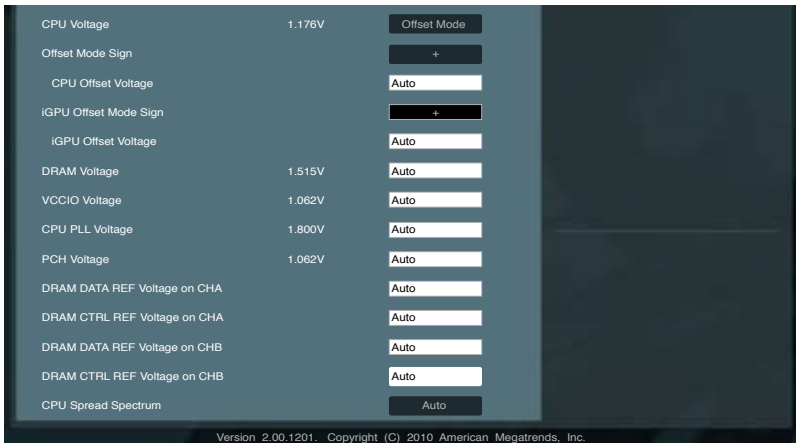

## Ai Overclock Tuner [Auto]

Allows you to select the CPU overclocking options to achieve the desired CPU internal frequency. Select any of these preset overclocking configuration options:

- [Auto] Loads the optimal settings for the system.
- [Manual] Allows you to individually set overclocking parameters.
- [X.M.P.] If you install memory modules supporting the eXtreme Memory Profile (X.M.P.) Technology, choose this item to set the profiles supported by your memory modules for optimizing the system performance.

## BCLK/PCIE Frequency [XXX]

Allows you to adjust the CPU and VGA frequency to enhance the system performance. Use the <+> and <-> keys to adjust the value. You can also key in the desired value using the numeric keypad. The values range from 80.0MHz to 300.0MHz.

## eXtreme Memory Profile [High Performance]

This item appears only when you set the **Ai Overclock Tuner** item to [X.M.P.] and allows you to select the X.M.P. mode supported by your memory module.  
Configuration options: [Disabled] [Profile #1] [Profile #2]

## Turbo Ratio [By All Cores]

Allows you to manually adjust the Turbo CPU ratio.

- [Auto] All Turbo ratio are set by Intel CPU default settings.
- [By ALL Cores (Can Adjust in OS)] All numbers of active cores will be set to one single Turbo ratio in OS.
- [By Per Core (Cannot Adjust in OS)] All numbers of active cores can be set to an individual Turbo ratio in BIOS.

## By ALL Cores (Can Adjust in OS) [XX]

This item appears only when you set the **Turbo Ratio** item to [By ALL Cores (Can Adjust in OS)]. Use the <+> and <-> keys to adjust the value.

## 1-/2-/3-/4-Core Ratio Limit [XX]

This item appears only when you set the **Turbo Ratio** item to [By Per Core (Cannot Adjust in OS)]. Use the <+> and <-> keys to adjust the value.

## Internal PLL Overvoltage [Auto]

Allows you to set the Internal PLL Overvoltage.  
Configuration options: [Auto] [Enabled] [Disabled]

## Memory Frequency [Auto]

Allows you to set the memory operating frequency. The configuration options vary with the **BCLK/PCIE Frequency** item settings.



---

Selecting a very high memory frequency may cause the system to become unstable! If this happens, revert to the default setting.

---

### iGPU Max. Frequency [XXXX]

Use the <+> and <-> keys to adjust the value. The values range from 1100MHz to 3000MHz with a 50MHz interval.

### EPU Power Saving MODE [Disabled]

Allows you to enable or disable the EPU power saving function.

Configuration options: [Disabled] [Enabled]

### EPU Setting [Auto]

This item appears only when you set the **EPU Power Saving MODE** item to [Enabled.] and allows you to select the EPU power saving mode.

Configuration options: [Auto] [Light Power Saving Mode] [Medium Power Saving Mode] [Max Power Saving Mode]

### OC Tuner

OC Tuner automatically overclocks the frequency and voltage of CPU and DRAM for enhancing the system performance. Configuration options: [OK] [Cancel]

### DRAM Timing Control

The sub-items in this menu allow you to set the DRAM timing control features. Use the <+> and <-> keys to adjust the value. To restore the default setting, type [auto] using the keyboard and press the <Enter> key.



---

Changing the values in this menu may cause the system to become unstable! If this happens, revert to the default settings.

---

### CPU Power Management

The sub-items in this menu allow you to set the CPU ratio and features.

#### CPU Ratio [Auto]

Allows you to manually adjust the maximum non-turbo CPU ratio. Use <+> and <-> keys to adjust the value. The valid value ranges vary according to your CPU model.

#### Enhanced Intel SpeedStep Technology [Enabled]

Allows you to enable or disable the Enhanced Intel® SpeedStep Technology (EIST).

[Disabled] Disables this function.

[Enabled] The operating system dynamically adjusts the processor voltage and core frequency which may result in decreased average consumption and decreased average heat production.

#### Turbo Mode [Enabled]

This item appears only when you set the **EIST** item to [Enabled].

[Enabled] Allows processor cores to run faster than marked frequency in specific condition.

[Disabled] Disables this function.



---

The following five items appear only when you set the **EIST** and **Turbo Mode** items to [Enabled].

---

#### Long Duration Power Limit [Auto]

Use the <+> and <-> keys to adjust the value.

#### Long Duration Maintained [Auto]

Use the <+> and <-> keys to adjust the value.

#### Short Duration Power Limit [Auto]

Use the <+> and <-> keys to adjust the value.

#### Additional Turbo Voltage [Auto]

Use the <+> and <-> keys to adjust the value.

#### Primary Plane Current Limit [Auto]

Maximum instantaneous current allowed at any given time for CPU cores.

Use <+> and <-> key to adjust the value at 0.125A increment.

## DIGI+ VRM

### Load-Line Calibration [Auto]

Load-line is defined by Intel VRM spec and affects CPU voltage. The CPU working voltage will decrease proportionally to CPU loading. Higher load-line calibration would get higher voltage and better overclocking performance, but increase the CPU and VRM thermal. This item allows you to adjust the voltage range from the following percentages to boost the system performance: 0% (Regular), 25% (Medium), 50% (High), 75% (Ultra High) and 100% (Extreme).

Configuration options: [Auto] [Regular] [Medium] [High] [Ultra High] [Extreme]



---

The actual performance boost may vary depending on your CPU specification.

---

### VRM Frequency [Auto]

Switching frequency will affect the VRM transient response and component thermal. Setting a higher frequency gets faster transient response.

[Auto] Allows you to enable or disable the Spread Spectrum item.

[Manual] Allows you to manually set the frequency with a 10k Hz interval.

### VRM Spread Spectrum [Disabled]

This item appears only when you set the **Frequency** item to [Auto] and allows you to enable the spread spectrum to enhance system stability.

### VRM Fixed Frequency Mode [XXX]

This item appears only when you set the **VRM Frequency** item to [Manual] and allows you to set a fixed VRM frequency. Use the <+> and <-> keys to adjust the value. The values range from 300k Hz to 500k Hz with a 10k Hz interval.

### Phase Control [Extreme]

Phase number is the number of working VRM phase. Increasing phase number under heavy system loading to get more transient and better thermal performance. Reducing phase number under light system loading to increase VRM efficiency

- [Standard] Proceeds phase control depending on the CPU loading.
- [Optimized] Loads the ASUS optimized phase tuning profile.
- [Extreme] Proceeds the full phase mode.
- [Manual Adjustment] Allows manual adjustment.

### Manual Adjustment [Medium]

This item appears only when you set the **Phase Control** item to [Manual Adjustment].  
Configuration options: [Ultra Fast] [Fast] [Medium] [Regular]

### Duty Control [T.Probe]

- [T.Probe] Maintains the VRM thermal balance.
- [Extreme] Maintains the VRM current balance.

### CPU Current Capability [100%]

This item provides wider total power range for overclocking. A higher value brings a wider total power range and extends the overclocking frequency range simultaneously.  
Configuration options: [100%] [110%] [120%] [130%] [140%]

### iGPU Load-line Calibration [Auto]

Allows you to set the iGPU Load-line Calibration.  
Configuration options: [Auto] [Regular] [High] [Extreme]

### iGPU Current Capability [100%]

Allows you to set the iGPU Current Capability.  
Configuration options: [100%] [140%]



Do not remove the thermal module while changing the DIGI+ VRM related parameters .  
The thermal conditions should be monitored.



Some of the following items are adjusted by typing the desired values using the numeric keypad and press the <Enter> key. You can also use the <+> and <-> keys to adjust the value. To restore the default setting, type [auto] using the keyboard and press the <Enter> key.

### CPU Voltage [Offset Mode]

- [Manual Mode] Allows you to set a fixed CPU voltage.
- [Offset Mode] Allows you to set the Offset voltage.

### Offset Mode Sign [+]

This item appears only when you set the **CPU Voltage** item to [Offset Mode].

- [+] To offset the voltage by a positive value.
- [-] To offset the voltage by a negative value.

### CPU Offset Voltage [Auto]

This item appears only when you set the **CPU Voltage** item to [Offset Mode] and allows you to set the Offset voltage. The values range from 0.005V to 0.635V with a 0.005V interval.

### CPU Manual Voltage [Auto]

This item appears only when you set the **CPU Voltage** item to [Manual Mode] and allows you to set a fixed CPU voltage. The values range from 0.800V to 1.990V with a 0.005V interval.



Refer to the CPU documentation before setting the CPU voltage. Setting a high voltage may damage the CPU permanently, and setting a low voltage may make the system unstable.

## **iGPU Offset Mode Sign [+]**

[+] To offset the voltage by a positive value.

[-] To offset the voltage by a negative value.

### iGPU Offset Voltage [Auto]

Allows you to set the iGPU Offset voltage. The values range from 0.005V to 0.635V with a 0.005V interval.

## **DRAM Voltage [Auto]**

Allows you to set the DRAM voltage. The values range from 1.20V to 2.20V with a 0.00625V interval.



According to Intel CPU spec, DIMMs with voltage requirement over 1.65V may damage the CPU permanently. We recommend you install the DIMMs with the voltage requirement below 1.65V.

## **VCCIO Voltage [Auto]**

Allows you to set the VCCIO voltage. The values range from 0.80V to 1.70V with a 0.00625V interval.

## **CPU PLL Voltage [Auto]**

Allows you to set the CPU and PCH PLL voltage. The values range from 1.20V to 2.20V with a 0.00625V interval.

## **PCH Voltage [Auto]**

Allows you to set the Platform Controller Hub voltage. The values range from 0.80V to 1.70V with a 0.01V interval.



- The values of the CPU Manual Voltage, CPU Offset Voltage, DRAM Voltage, VCCIO Voltage, CPU PLL Voltage, and PCH Voltage items are labeled in different color, indicating the risk levels of high voltage settings.
- The system may need better cooling system to work stably under high voltage settings.

	Black	Yellow	Pink	Red
<b>CPU Manual Voltage</b>	0.8V–1.22V	1.225V–1.280V	1.285V–1.335V	1.340V–1.990V
<b>CPU Offset Voltage</b>	0.005V–0.060V	0.065V–0.120V	0.125V–0.175V	0.180V–0.635V
<b>iGPU Offset Voltage</b>	0.005V–0.035V	0.04V–0.065V	0.07V–0.1V	0.105V–0.635V
<b>DRAM Voltage</b>	1.20000V– 1.57500V	1.58125V– 1.65000V	1.65625V– 1.72500V	1.73125V– 2.20000V
<b>VCCIO Voltage</b>	0.80000V– 1.10000V	1.10625V– 1.15000V	1.15625V– 1.20625V	1.21250V– 1.70000V
<b>CPU PLL Voltage</b>	1.20000V– 1.88750V	1.89375V– 1.97500V	1.98125V– 2.06875V	2.07500V– 2.20000V
<b>PCH Voltage</b>	0.80000V– 1.10000V	1.11000V– 1.15000V	1.16000V– 1.20000V	1.21000V– 1.70000V

### DRAM DATA REF Voltage on CHA/B [Auto]

Allows you to set the DRAM DATA Reference Voltage on Channel A/B. The values range from 0.395x to 0.630x with a 0.005x interval. Different ratio might enhance DRAM overclocking ability.

### DRAM CTRL REF Voltage on CHA/B [Auto]

Allows you to set the DRAM Control Reference Voltage on Channel A/B. The values range from 0.395x to 0.630x with a 0.005x interval. Different ratio might enhance DRAM overclocking ability.

### CPU Spread Spectrum [Auto]

- [Auto] Automatic configuration.
- [Disabled] Enhances the BCLK overclocking ability.
- [Enabled] Sets to [Enabled] for EMI control.

# 3.5 Advanced menu

The Advanced menu items allow you to change the settings for the CPU and other system devices.



Be cautious when changing the settings of the Advanced menu items. Incorrect field values can cause the system to malfunction.





### 3.5.1 CPU Configuration

The items in this menu show the CPU-related information that the BIOS automatically detects.



The items shown in this screen may be different due to the CPU you installed.



Scroll down to display the following items:



#### CPU Ratio [Auto]

Allows you to set the ratio between the CPU Core Clock and the BCLK Frequency. Use <+> and <-> keys to adjust the ratio. The valid value ranges vary according to your CPU model.

#### Intel Adaptive Thermal Monitor [Enabled]

[Enabled] Enables the overheated CPU to throttle its clock speed to cool down.

[Disabled] Disables the CPU thermal monitor function.

### **Hyper-threading [Enabled]**

The Intel Hyper-Threading Technology allows a hyper-threading processor to appear as two logical processors to the operating system, allowing the operating system to schedule two threads or processes simultaneously.

[Enabled] Two threads per activated core are enabled.

[Disabled] Only one thread per activated core is enabled.

### **Active Processor Cores [All]**

Allows you to choose the number of CPU cores to activate in each processor package.

Configuration options: [All] [1] [2] [3]

### **Limit CPUID Maximum [Disabled]**

[Enabled] Allows legacy operating systems to boot even without support for CPUs with extended CPUID functions.

[Disabled] Disables this function.

### **Execute Disable Bit [Enabled]**

[Enabled] Enables the No-Execution Page Protection Technology.

[Disabled] Forces the XD feature flag to always return to zero (0).

### **Intel(R) Virtualization Tech [Disabled]**

[Enabled] Allows a hardware platform to run multiple operating systems separately and simultaneously, enabling one system to virtually function as several systems.

[Disabled] Disables this function.

### **Enhanced Intel SpeedStep Technology [Enabled]**

Allows you to enable or disable the Enhanced Intel® SpeedStep Technology (EIST).

[Disabled] The CPU runs at its default speed.

[Enabled] The operating system controls the CPU speed.

### **Turbo Mode [Enabled]**

This item appears only when you set the **EIST** item to [Enabled] and allows you to enable or disable the Intel® Turbo Mode Technology.

[Enabled] Allows processor cores to run faster than marked frequency in specific condition.

[Disabled] Disables this function.

### **CPU C1E [Auto]**

[Enabled] Enables the C1E support function. This item should be enabled in order to enable the Enhanced Halt State.

[Disabled] Disables this function.

### **CPU C3 Report [Auto]**

Allows you to disable or enable the CPU C3 report to OS.

### **CPU C6 Report [Auto]**

Allows you to disable or enable the CPU C6 report to OS.

## 3.5.2 System Agent Configuration

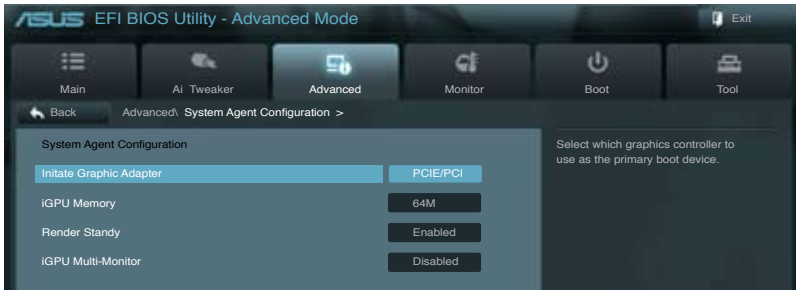

### Initiate Graphic Adapter [PCIE/PCI]

Allows you to decide which graphics controller to use as the primary boot device.  
Configuration options: [iGPU] [PCI/iGPU] [PCI/PCIE] [PCIE/PCI]

### iGPU Memory [64M]

Allows you to set the iGPU Memory. Configuration options: [32M] [64M] [96M] [128M]

### Render Standby [Enabled]

Allows you to set the Render Standby. Configuration options: [Disabled] [Enabled]

### iGPU Multi-Monitor [Disabled]

Allows you to set the iGPU Multi-Monitor. Configuration options: [Disabled] [Enabled]

## 3.5.3 PCH Configuration

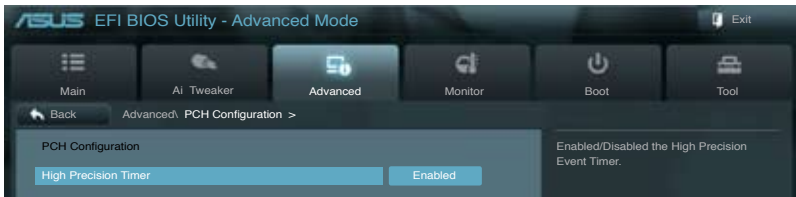

### High Precision Timer [Enabled]

Allows you to enable or disable the High Precision Event Timer.  
Configuration options: [Enabled] [Disabled]

### 3.5.4 SATA Configuration

While entering Setup, the BIOS automatically detects the presence of SATA devices. The SATA Port items show **Not Present** if no SATA device is installed to the corresponding SATA port.



Scroll down to display the following items:

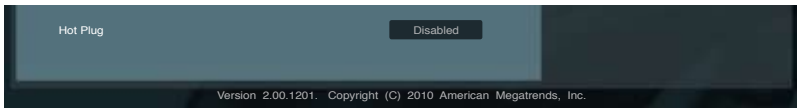

#### SATA Mode [AHCI Mode]

Allows you to set the SATA configuration.

- [Disabled] Disables the SATA function.
- [IDE Mode] Set to [IDE Mode] when you want to use the Serial ATA hard disk drives as Parallel ATA physical storage devices.
- [AHCI Mode] Set to [AHCI Mode] when you want the SATA hard disk drives to use the AHCI (Advanced Host Controller Interface). The AHCI allows the onboard storage driver to enable advanced Serial ATA features that increases storage performance on random workloads by allowing the drive to internally optimize the order of commands.
- [RAID Mode] Set to [RAID Mode] when you want to create a RAID configuration from the SATA hard disk drives.

#### Serial-ATA Controller 0 [Enhanced]

This item appear only when you set the previous item to [IDE Mode]

- [Disabled] Disables the SATA function.
- [Enhanced] Set to [Enhanced] to support two SATA 6.0 Gb/s and two SATA 3.0 Gb/s devices.
- [Compatible] Set to [Compatible] when using Windows 98/NT/2000/MS-DOS. Up to four SATA devices are supported under these operating systems.

### **Serial-ATA Controller 1 [Enhanced]**

- [Disabled] Disables the SATA function.
- [Enhanced] Set to [Enhanced] to support 2 SATA 3Gb/s devices.

### **S.M.A.R.T. Status Check [Enabled]**

S.M.A.R.T. (Self-Monitoring, Analysis and Reporting Technology) is a monitor system. When read/write of your hard disk errors occur, this feature allows the hard disk to report warning messages during the POST.

Configuration options: [Enabled] [Disabled]

### 3.5.5 USB Configuration

The items in this menu allow you to change the USB-related features.

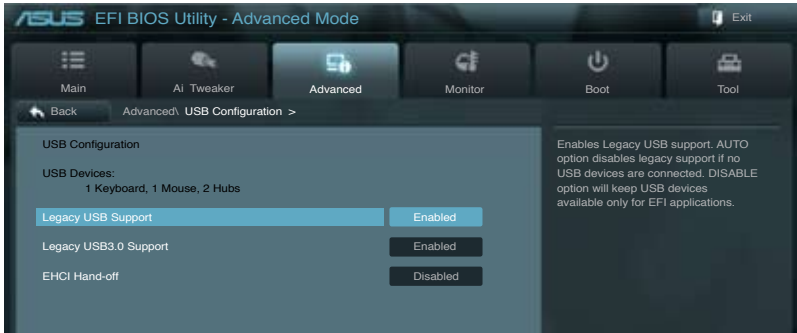

The **USB Devices** item shows the auto-detected values. If no USB device is detected, the item shows **None**.

#### Legacy USB Support [Enabled]

- [Enabled] Enables the support for USB devices on legacy operating systems (OS).
- [Disabled] The USB devices can be used only for the BIOS setup program.
- [Auto] Allows the system to detect the presence of USB devices at startup. If detected, the USB controller legacy mode is enabled. If no USB device is detected, the legacy USB support is disabled.

#### Legacy USB3.0 Support [Enabled]

- [Enabled] Enables the support for USB 3.0 devices on legacy operating systems (OS).
- [Disabled] Disables the function.

#### EHCI Hand-off [Disabled]

- [Enabled] Enables the support for operating systems without an EHCI hand-off feature.
- [Disabled] Disables the function.

### 3.5.6 Onboard Devices Configuration

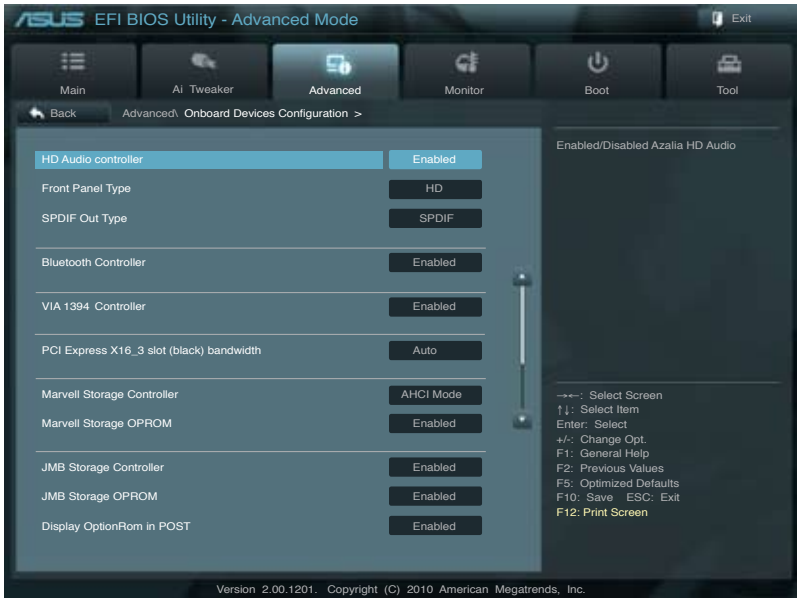

Scroll down to display the following items:

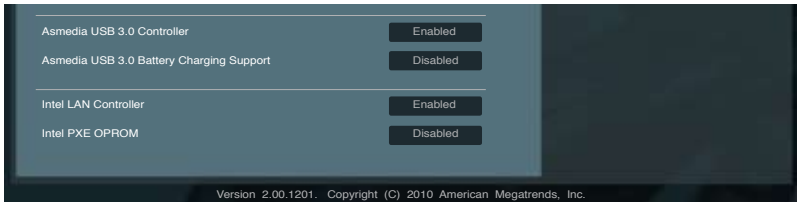

#### HD Audio Controller [Enabled]

[Enabled] Enables the High Definition Audio Controller.

[Disabled] Disables the controller.



The following two items appear only when you set the **Azalia HD Audio** item to [Enabled].

#### Front Panel Type [HD]

Allows you to set the front panel audio connector (AAFP) mode to legacy AC'97 or high-definition audio depending on the audio standard that the front panel audio module supports.

[HD] Sets the front panel audio connector (AAFP) mode to high definition audio.

[AC97] Sets the front panel audio connector (AAFP) mode to legacy AC'97

## SPDIF Out Type [SPDIF]

- [SPDIF] Sets to [SPDIF] for SPDIF audio output.
- [HDMI] Sets to [HDMI] for HDMI audio output.

## Bluetooth Controller [Enabled]

- [Enabled] Enables the onboard bluetooth controller.
- [Disabled] Disables the controller.

## VIA 1394 Controller [Enabled]

- [Enabled] Enables the onboard IEEE 1394a controller.
- [Disabled] Disables the controller.

## PCI Express X16\_3 slot (black) bandwidth [Auto]

Allows you to select the PCI Express X16\_3 slot (black) bandwidth.

- [Auto] PCIeX16\_3 slot runs at X1 mode for system resource optimization. (PCIeX1\_2 will be disabled.)
- [X4 mode] PCIeX16\_3 slot runs at X4 mode for high performance support. (USB3\_34, eSATA ports, PCIeX1\_1, PCIeX1\_2 will be disabled.)
- [X1 mode] PCIeX16\_3 slot runs at X1 mode with all slots enabled. (USB3\_34 will be disabled.)

## Marvell Storage Controller [AHCI Mode]

Allows you to select the Marvell storage controller operating mode.

- [Disabled] Disables the controller.
- [IDE Mode] Set to [IDE Mode] when you want to use the Serial ATA hard disk drives as Parallel ATA physical storage devices.
- [AHCI Mode] Set to [AHCI Mode] when you want the SATA hard disk drives to use the AHCI (Advanced Host Controller Interface). The AHCI allows the onboard storage driver to enable advanced Serial ATA features that increases storage performance on random workloads by allowing the drive to internally optimize the order of commands.

## Marvell Storage OPROM [Enabled]

This item appears only when you set the previous item to [Enabled] and allows you to enable or disable the OptionRom of the Marvell storage controller.  
Configuration options: [Enabled] [Disabled]

## JMB Storage Controller [Enabled]

Allows you to enable or disable the JMB storage controller.  
Configuration options: [Disabled] [Enabled]



---

If you want to use the full function of the JMB storage controller (ex. AHCI), we recommend that you set this item to [Enabled] and install the **JMicron JMB36X Controller Driver** from the motherboard support DVD.

---



### **JMB Storage OPROM [Enabled]**

This item appears only when you set the previous item to [Enabled] and allows you to enable or disable the OptionRom of the JMB storage controller.

Configuration options: [Enabled] [Disabled]

### **Display OptionRom in POST [Enabled]**

This item appears only when you set the **JMB Storage OPROM** item to [Enabled] and allows you to display or hide the OptionRom of the JMB storage controller during POST.

Configuration options: [Enabled] [Disabled]

### **Intel LAN Controller [Enabled]**

[Enabled] Enables the Intel LAN controller.

[Disabled] Disables the controller.

### **Intel PXE OPROM [Disabled]**

This item appears only when you set the previous item to [Enabled] and allows you to enable or disable the PXE OptionRom of the Intel LAN controller.

Configuration options: [Enabled] [Disabled]

### **Asmedia USB 3.0 Controller [Enabled]**

[Enabled] Enables the USB 3.0 controller.

[Disabled] Disables the controller.

### **Asmedia USB 3.0 Battery Charging Support [Disabled]**

[Enabled] Enables Asmedia USB 3.0 fast battery charging support for USB 3.0 devices complying with the BC 1.1 regulation.

[Disabled] Disables battery charging support.

### 3.5.7 APM

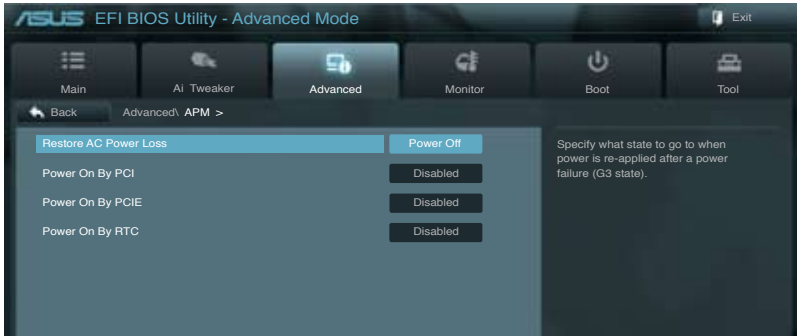

#### Restore AC Power Loss [Power Off]

- [Power On] The system goes into on state after an AC power loss.
- [Power Off] The system goes into off state after an AC power loss.
- [Last State] The system goes into either off or on state, whatever the system state was before the AC power loss.

#### Power On By PCI [Disabled]

- [Disabled] Disables the PME to wake up from S5 by PCI devices.
- [Enabled] Allows you to turn on the system through a PCI LAN or modem card. This feature requires an ATX power supply that provides at least 1A on the +5VSB lead.

#### Power On By PCIE [Disabled]

- [Disabled] Disables the PCIE devices to generate a wake event.
- [Enabled] Enables the PCIE devices to generate a wake event.

#### Power On By RTC [Disabled]

- [Disabled] Disables RTC to generate a wake event.
- [Enabled] When set to [Enabled], the items **RTC Alarm Date (Days)** and **Hour/Minute/Second** will become user-configurable with set values.

## 3.6 Monitor menu

The Monitor menu displays the system temperature/power status, and allows you to change the fan settings.

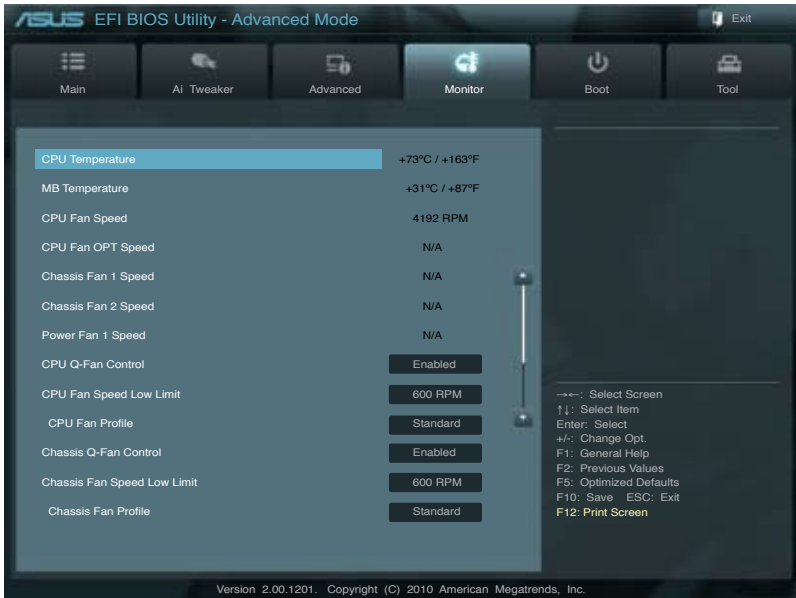

Scroll down to display the following items:

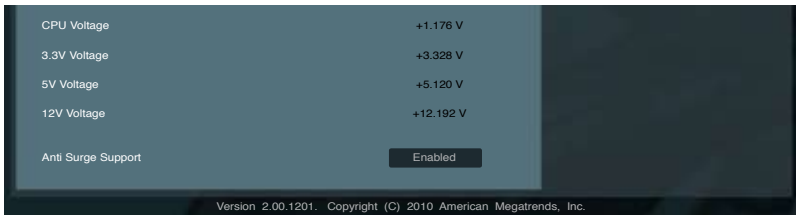

### CPU Temperature / MB Temperature [xxx°C/xxx°F]

The onboard hardware monitor automatically detects and displays the CPU and motherboard temperatures. Select **Ignore** if you do not wish to display the detected temperatures.

### CPU Fan Speed [xxxx RPM] or [Ignore] / [N/A]

### CPU Fan OPT Speed [xxxx RPM] or [Ignore] / [N/A]

### Chassis Fan 1/2 Speed [xxxx RPM] or [Ignore] / [N/A]

### Power Fan 1 Speed [xxxx RPM] or [Ignore] / [N/A]

The onboard hardware monitor automatically detects and displays the CPU, chassis, and power fan speed in rotations per minute (RPM). If the fan is not connected to the motherboard, the field shows **N/A**. Select **Ignore** if you do not wish to display the detected speed.

## CPU Q-Fan Control [Enabled]

[Disabled] Disables the CPU Q-Fan control feature.

[Enabled] Enables the CPU Q-Fan control feature.

## CPU Fan Speed Low Limit [600 RPM]

This item appears only when you enable the **CPU Q-Fan Control** feature and allows you to disable or set the CPU fan warning speed.

Configuration options: [Ignore] [200 RPM] [300 RPM] [400 RPM] [500 RPM] [600 RPM]

### *CPU Fan Profile [Standard]*

This item appears only when you enable the **CPU Q-Fan Control** feature and allows you to set the appropriate performance level of the CPU fan.

[Standard] Sets to [Standard] to make the CPU fan automatically adjust depending on the CPU temperature.

[Silent] Sets to [Silent] to minimize the fan speed for quiet CPU fan operation.

[Turbo] Sets to [Turbo] to achieve maximum CPU fan speed.

[Manual] Sets to [Manual] to assign detailed fan speed control parameters.



---

The following four items appear only when you set **CPU Fan Profile** to [Manual].

---

### **CPU Upper Temperature [70]**

Use the <+> and <-> keys to adjust the upper limit of the CPU temperature. The values range from 40°C to 90°C.

### **CPU Fan Max. Duty Cycle(%) [100]**

Use the <+> and <-> keys to adjust the maximum CPU fan duty cycle. The values range from 20% to 100%. When the CPU temperature reaches the upper limit, the CPU fan will operate at the maximum duty cycle.

### **CPU Lower Temperature [20]**

Displays the lower limit of the CPU temperature.

### **CPU Fan Min. Duty Cycle(%) [20]**

Use the <+> and <-> keys to adjust the minimum CPU fan duty cycle. The values range from 0% to 100%. When the CPU temperature is under 40°C, the CPU fan will operate at the minimum duty cycle.

## Chassis Q-Fan Control [Enabled]

[Disabled] Disables the Chassis Q-Fan control feature.

[Enabled] Enables the Chassis Q-Fan control feature.

## Chassis Fan Speed Low Limit [600 RPM]

This item appears only when you enable the **Chassis Q-Fan Control** feature and allows you to disable or set the chassis fan warning speed.

Configuration options: [Ignore] [200 RPM] [300 RPM] [400 RPM] [500 RPM] [600 RPM]

### Chassis Fan Profile [Standard]

This item appears only when you enable the **Chassis Q-Fan Control** feature and allows you to set the appropriate performance level of the chassis fan.

- [Standard] Sets to [Standard] to make the chassis fan automatically adjust depending on the chassis temperature.
- [Silent] Sets to [Silent] to minimize the fan speed for quiet chassis fan operation.
- [Turbo] Sets to [Turbo] to achieve maximum chassis fan speed.
- [Manual] Sets to [Manual] to assign detailed fan speed control parameters.



---

The following four items appear only when you set **Chassis Fan Profile** to [Manual].

---

#### **Chassis Upper Temperature [70]**

Use the <+> and <-> keys to adjust the upper limit of the CPU temperature. The values range from 40°C to 90°C.

#### **Chassis Fan Max. Duty Cycle(%) [100]**

Use the <+> and <-> keys to adjust the maximum chassis fan duty cycle. The values range from 20% to 100%. When the chassis temperature reaches the upper limit, the chassis fan will operate at the maximum duty cycle.

#### **Chassis Lower Temperature [40]**

Displays the lower limit of the chassis temperature.

#### **CPU Fan Min. Duty Cycle(%) [60]**

Use the <+> and <-> keys to adjust the minimum chassis fan duty cycle. The values range from 0% to 100%. When the chassis temperature is under 40°C, the chassis fan will operate at the minimum duty cycle.

### **CPU Voltage, 3.3V Voltage, 5V Voltage, 12V Voltage**

The onboard hardware monitor automatically detects the voltage output through the onboard voltage regulators. Select **Ignore** if you do not want to detect this item.

#### **Anti Surge Support [Enabled]**

This item allows you to enable or disable the Anti Surge function.  
Configuration options: [Disabled] [Enabled]

## 3.7 Boot menu

The Boot menu items allow you to change the system boot options.

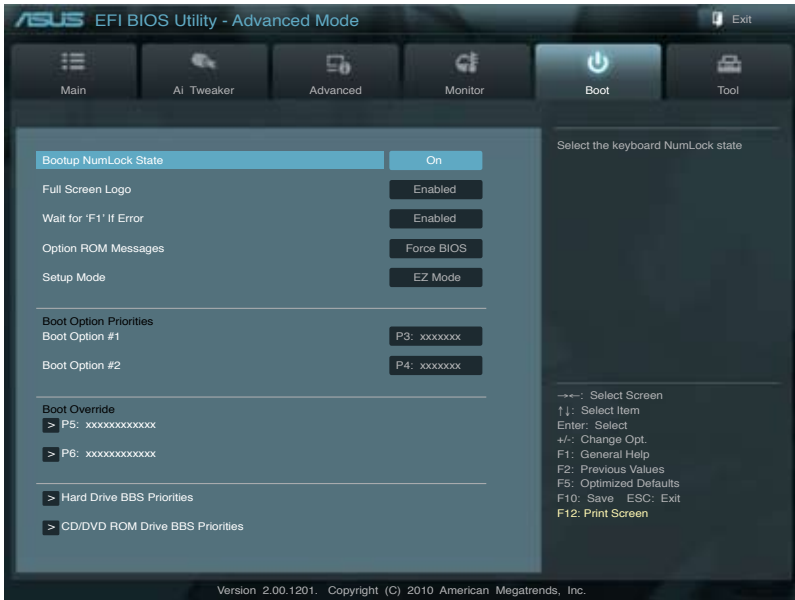

### Bootup NumLock State [On]

[On] Sets the power-on state of the NumLock to [On].

[Off] Sets the power-on state of the NumLock to [Off].

### Full Screen Logo [Enabled]

[Enabled] Enables the full screen logo display feature.

[Disabled] Disables the full screen logo display feature.



Set this item to [Enabled] to use the ASUS MyLogo 2™ feature.

### Wait For 'F1' If Error [Enabled]

[Disabled] Disables this function.

[Enabled] The system waits for the <F1> key to be pressed when error occurs.

### Option ROM Messages [Force BIOS]

[Force BIOS] The third-party ROM messages will be forced to display during the boot sequence.

[Keep Current] The third-party ROM messages will be displayed only if the third-party manufacturer had set the add-on device to do so.

## Setup Mode [EZ Mode]

[Advanced Mode] Sets Advanced Mode as the default screen for entering the BIOS setup program.

[EZ Mode] Sets EZ Mode as the default screen for entering the BIOS setup program.

## Boot Option Priorities

These items specify the boot device priority sequence from the available devices. The number of device items that appears on the screen depends on the number of devices installed in the system.



- To select the boot device during system startup, press <F8> when ASUS Logo appears.
- To access Windows OS in Safe Mode, do any of the following:
  - Press <F5> when ASUS Logo appears.
  - Press <F8> after POST.

## Boot Override

These items displays the available devices. The number of device items that appears on the screen depends on the number of devices installed in the system. Click an item to start booting from the selected device.

## 3.8 Tools menu

The Tools menu items allow you to configure options for special functions. Select an item then press <Enter> to display the submenu.

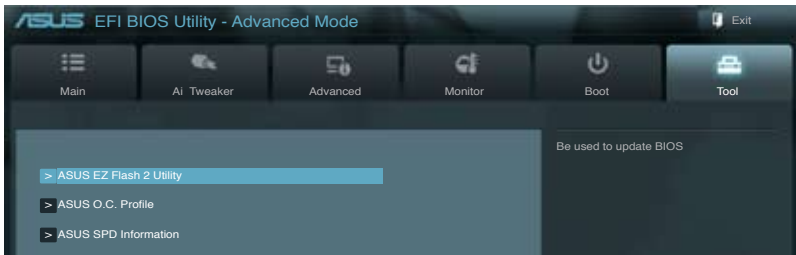

### 3.8.1 ASUS EZ Flash 2 Utility

Allows you to run ASUS EZ Flash 2. When you press <Enter>, a confirmation message appears. Use the left/right arrow key to select between [Yes] or [No], then press <Enter> to confirm your choice.



For more details, refer to **section 3.10.2 ASUS EZ Flash 2 utility**.

### 3.8.2. ASUS O.C. Profile

This item allows you to store or load multiple BIOS settings.

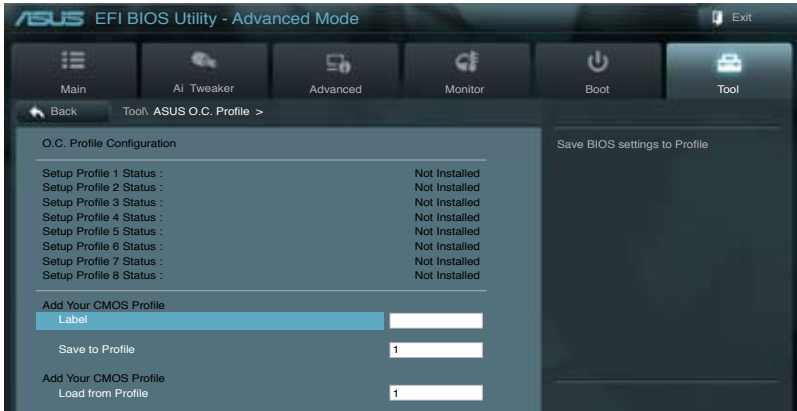

---

The **Setup Profile Status** items show **Not Installed** if no profile is created.

---

#### Save to Profile

Allows you to save the current BIOS settings to the BIOS Flash, and create a profile. Key in a profile number from one to eight, press <Enter>, and then select **Yes**.

#### Load from Profile

Allows you to load the previous BIOS settings saved in the BIOS Flash. Key in the profile number that saved your BIOS settings, press <Enter>, and then select **Yes**.



- DO NOT shut down or reset the system while updating the BIOS to prevent the system boot failure!
  - We recommend that you update the BIOS file only coming from the same memory/CPU configuration and BIOS version.
-



## 3.9 Exit menu

The Exit menu items allow you to load the optimal default values for the BIOS items, and save or discard your changes to the BIOS items. You can access the **EZ Mode** from the Exit menu.

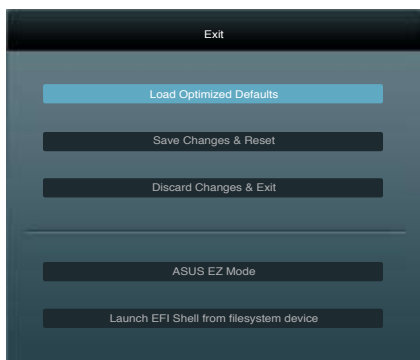

### Load Optimized Defaults

This option allows you to load the default values for each of the parameters on the Setup menu. When you select this option or if you press <F5>, a confirmation window appears. Select **Yes** to load the default values.

### Save Changes & Reset

Once you are finished making your selections, choose this option from the Exit menu to ensure the values you selected are saved. When you select this option or if you press <F10>, a confirmation window appears. Select **Yes** to save changes and exit.

### Discard Changes & Exit

This option allows you to exit the Setup program without saving your changes. When you select this option or if you press <Esc>, a confirmation window appears. Select **Yes** to discard changes and exit.

### ASUS EZ Mode

This option allows you to enter the EZ Mode screen.

### Launch EFI Shell from filesystem device

This option allows you to attempt to launch the EFI Shell application (shellx64.efi) from one of the available filesystem devices.

## 3.10 Updating BIOS

The ASUS website publishes the latest BIOS versions to provide enhancements on system stability, compatibility, or performance. However, BIOS updating is potentially risky. If there is no problem using the current version of BIOS, **DO NOT manually update the BIOS**. Inappropriate BIOS updating may result in the system's failure to boot. Carefully follow the instructions of this chapter to update your BIOS if necessary.



---

Visit the ASUS website ([www.asus.com](http://www.asus.com)) to download the latest BIOS file for this motherboard.

---

The following utilities allow you to manage and update the motherboard BIOS setup program.

1. **ASUS Update:** Updates the BIOS in Windows® environment.
2. **ASUS EZ Flash 2:** Updates the BIOS using a USB flash drive.
3. **ASUS CrashFree BIOS 3:** Restores the BIOS using the motherboard support DVD or a USB flash drive when the BIOS file fails or gets corrupted.
4. **ASUS BIOS Updater:** Updates and backups the BIOS in DOS environment using the motherboard support DVD and a USB flash disk drive.

Refer to the corresponding sections for details on these utilities.



---

Save a copy of the original motherboard BIOS file to a USB flash disk in case you need to restore the BIOS in the future. Copy the original motherboard BIOS using the **ASUS Update** or **BIOS Updater** utilities.

---

### 3.10.1 ASUS Update utility

The ASUS Update is a utility that allows you to manage, save, and update the motherboard BIOS in Windows® environment. The ASUS Update utility allows you to:

- Update the BIOS directly from the Internet
- Download the latest BIOS file from the Internet
- Update the BIOS from an updated BIOS file
- Save the current BIOS file
- View the BIOS version information

This utility is available in the support DVD that comes with the motherboard package.



---

ASUS Update requires an Internet connection either through a network or an Internet Service Provider (ISP).

---

#### Launching ASUS Update

After installing AI Suite II from the motherboard support DVD, launch ASUS Update by clicking **Update > ASUS Update** on the AI Suite II main menu bar.



---

Quit all Windows® applications before you update the BIOS using this utility.

---

## Updating the BIOS through the Internet

To update the BIOS through the Internet:

1. From the ASUS Update screen, select **Update BIOS from Internet**, and then click **Next**.



2. Select the ASUS FTP site nearest you to avoid network traffic.

If you want to enable the BIOS downgradable function and auto BIOS backup function, check the checkboxes before the two items on the screen.



3. Select the BIOS version that you want to download. Click **Next**.



4. You can decide whether to change the BIOS boot logo, which is the image appearing on screen during the Power-On Self-Tests (POST). Click **Yes** if you want to change the boot logo or **No** to continue.
5. Follow the onscreen instructions to complete the update process.



## Updating the BIOS through a BIOS file

To update the BIOS through a BIOS file:

1. From the ASUS Update screen, select **Update BIOS from file**, and then click **Next**.



2. Locate the BIOS file from the Open window, click **Open**, and click **Next**.



3. You can decide whether to change the BIOS boot logo. Click **Yes** if you want to change the boot logo or **No** to continue.
4. Follow the onscreen instructions to complete the update process.



- The screenshots in this section are for reference only. The actual BIOS information vary by models.
- Refer to the software manual in the support DVD or visit the ASUS website at [www.asus.com](http://www.asus.com) for detailed software configuration.

### 3.10.2 ASUS EZ Flash 2 utility

The ASUS EZ Flash 2 feature allows you to update the BIOS without having to use a bootable floppy disk or an OS-based utility.



Before you start using this utility, download the latest BIOS from the ASUS website at [www.asus.com](http://www.asus.com).

To update the BIOS using EZ Flash 2:

1. Insert the USB flash disk that contains the latest BIOS file to the USB port.
2. Enter the Advanced Mode of the BIOS setup program. Go to the **Tool** menu to select **ASUS EZ Flash Utility** and press <Enter> to enable it.

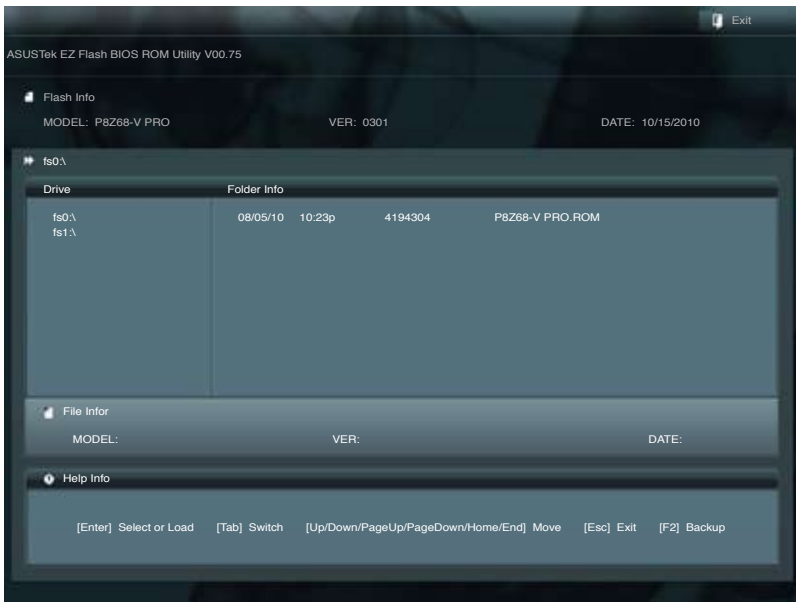

3. Press <Tab> to switch to the Drive field.
4. Press the Up/Down arrow keys to find the USB flash disk that contains the latest BIOS, and then press <Enter>.
5. Press <Tab> to switch to the Folder Info field.
6. Press the Up/Down arrow keys to find the BIOS file, and then press <Enter> to perform the BIOS update process. Reboot the system when the update process is done.



- 
- This function can support devices such as a USB flash disk with FAT 32/16 format and single partition only.
  - DO NOT shut down or reset the system while updating the BIOS to prevent system boot failure!
- 



---

Ensure to load the BIOS default settings to ensure system compatibility and stability. Select the **Load Optimized Defaults** item under the **Exit** menu. See section **3.9 Exit Menu** for details.

---

### 3.10.3 ASUS CrashFree BIOS 3 utility

The ASUS CrashFree BIOS 3 utility is an auto recovery tool that allows you to restore the BIOS file when it fails or gets corrupted during the updating process. You can restore a corrupted BIOS file using the motherboard support DVD or a USB flash drive that contains the BIOS file.



---

The BIOS file in the motherboard support DVD may be older than the BIOS file published on the ASUS official website. If you want to use the newer BIOS file, download the file at [support.asus.com](http://support.asus.com) and save it to a USB flash drive.

---

## Recovering the BIOS

To recover the BIOS:

1. Turn on the system.
2. Insert the motherboard support DVD to the optical drive, or the USB flash drive containing the BIOS file to the USB port.
3. The utility automatically checks the devices for the BIOS file. When found, the utility reads the BIOS file and enters ASUS EZ Flash 2 utility automatically.
4. The system requires you to enter BIOS Setup to recover BIOS setting. To ensure system compatibility and stability, we recommend that you press <F5> to load default BIOS values.



---

DO NOT shut down or reset the system while updating the BIOS! Doing so can cause system boot failure!

---

### 3.10.4 ASUS BIOS Updater

The ASUS BIOS Updater allows you to update BIOS in DOS environment. This utility also allows you to copy the current BIOS file that you can use as a backup when the BIOS fails or gets corrupted during the updating process.



The succeeding utility screens are for reference only. The actual utility screen displays may not be same as shown.

#### Before updating BIOS

1. Prepare the motherboard support DVD and a USB flash drive in FAT32/16 format and single partition.
2. Download the latest BIOS file and BIOS Updater from the ASUS website at <http://support.asus.com> and save them on the USB flash drive.



- NTFS is not supported under DOS environment. Do not save the BIOS file and BIOS Updater to a hard disk drive or USB flash drive in NTFS format.
- Do not save the BIOS file to a floppy disk due to low disk capacity.

3. Turn off the computer and disconnect all SATA hard disk drives (optional).

#### Booting the system in DOS environment

1. Insert the USB flash drive with the latest BIOS file and BIOS Updater to the USB port.
2. Boot your computer. When the ASUS Logo appears, press <F8> to show the **BIOS Boot Device Select Menu**. Insert the support DVD into the optical drive and select the optical drive as the boot device.

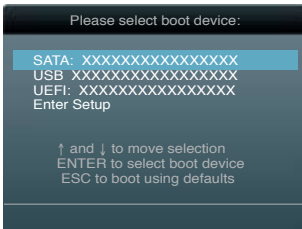

3. When the **Make Disk** menu appears, select the **FreeDOS command prompt** item by pressing the item number.
4. At the FreeDOS prompt, type **d:** and press <Enter> to switch the disk from Drive C (optical drive) to Drive D (USB flash drive).

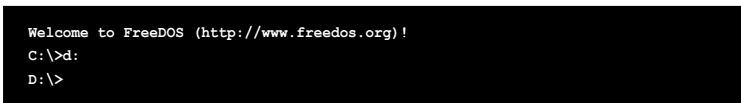

## Backing up the current BIOS

To backup the current BIOS file using the BIOS Updater



Ensure that the USB flash drive is not write-protected and has enough free space to save the file.

1. At the FreeDOS prompt, type `bupdater /o[filename]` and press <Enter>.

```
D:\>bupdater /oOLDBIOS1 .rom
```

Filename Extension

The [filename] is any user-assigned filename with no more than eight alphanumeric characters for the filename and three alphanumeric characters for the extension.

2. The BIOS Updater backup screen appears indicating the BIOS backup process. When BIOS backup is done, press any key to return to the DOS prompt.

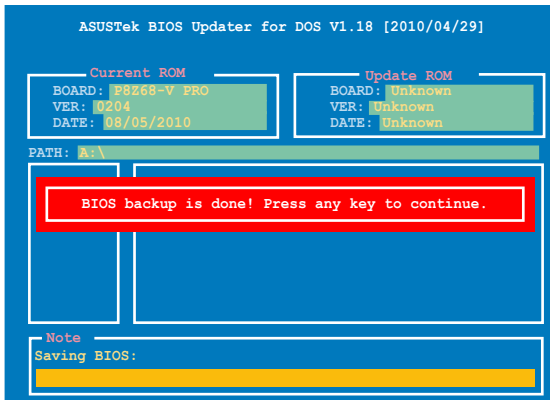



## Updating the BIOS file

To update the BIOS file using BIOS Updater

1. At the FreeDOS prompt, type `bupdater /pc /g` and press <Enter>.

```
D:\>bupdater /pc /g
```

2. The BIOS Updater screen appears as below.

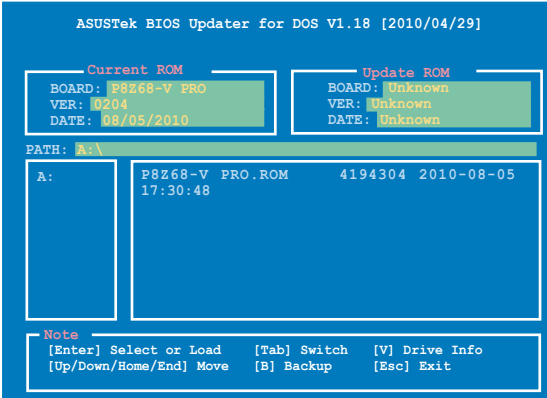

3. Press <Tab> to switch between screen fields and use the <Up/Down/Home/End> keys to select the BIOS file and press <Enter>. BIOS Updater checks the selected BIOS file and prompts you to confirm BIOS update.



4. Select **Yes** and press <Enter>. When BIOS update is done, press <ESC> to exit BIOS Updater. Restart your computer.



DO NOT shut down or reset the system while updating the BIOS to prevent system boot failure!



- For BIOS Updater version 1.04 or later, the utility automatically exits to the DOS prompt after updating BIOS.
- Ensure to load the BIOS default settings to ensure system compatibility and stability. Select the **Load Optimized Defaults** item under the **Exit** BIOS menu. See Chapter 3 of your motherboard user manual for details.
- Ensure to connect all SATA hard disk drives after updating the BIOS file if you have disconnected them.



# Chapter 4

## 4.1 Installing an operating system

This motherboard supports Windows® XP/ 64-bit XP/ Vista / 64-bit Vista / 7 / 64-bit 7 operating systems (OS). Always install the latest OS version and corresponding updates to maximize the features of your hardware.



- Motherboard settings and hardware options vary. Use the setup procedures presented in this chapter for reference only. Refer to your OS documentation for detailed information.
- Ensure that you install the Windows® XP Service Pack 3 or later versions before installing the drivers for better compatibility and system stability.

## 4.2 Support DVD information

The support DVD that comes with the motherboard package contains the drivers, software applications, and utilities that you can install to avail all motherboard features.



The contents of the support DVD are subject to change at any time without notice. Visit the ASUS website at [www.asus.com](http://www.asus.com) for updates.

### 4.2.1 Running the support DVD

Place the support DVD into the optical drive. The DVD automatically displays the Drivers menu if Autorun is enabled in your computer. Click each menu tab and select the items you want to install.

The Drivers menu shows the available device drivers if the system detects installed devices. Install the necessary drivers to use the devices.

The Make Disk menu contains items to create the RAID/AHCI driver disk.

The Manual menu contains the list of supplementary user manuals. Click an item to open the folder of the user manual.

The Utilities menu shows the applications and other software that the motherboard supports.

Click the Contact tab to display the ASUS contact information.

Click an icon to display DVD/motherboard information

Click an item to install

The screenshot shows the 'ASUS Install' window with a list of drivers: Norton Internet Security, 2011; Intel Chipset Driver; Intel Rapid Storage Technology, Driver, Software; Realtek Audio Driver; Management Engine Interface; Microware JME38X Controller Driver; Marvell SATA 6G Driver; Intel LAN Driver; Realtek LAN Driver; and ASUS Bluetooth Driver. At the top, there are tabs for 'ASUS Install', 'MB', 'DVD', and 'Contact'. A box highlights the driver list, and another box highlights the 'MB' and 'DVD' icons.



If Autorun is NOT enabled in your computer, browse the contents of the support DVD to locate the file ASSETUP.EXE from the BIN folder. Double-click the ASSETUP.EXE to run the DVD.

## 4.2.2 Obtaining the software manuals

The software manuals are included in the support DVD. Follow the instructions below to get the necessary software manuals.



The software manual files are in Portable Document Format (PDF). Install the Adobe® Acrobat® Reader from the Utilities menu before opening the files.

1. Click the **Manual** tab. Click **ASUS Motherboard Utility Guide** from the manual list on the left.



2. The **Manual** folder of the support DVD appears. Double-click the folder of your selected software.

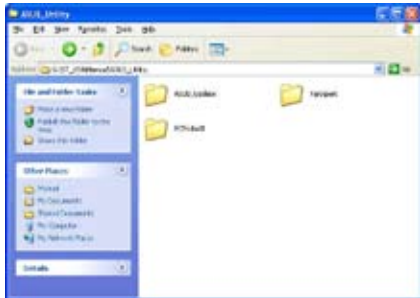

3. Some software manuals are provided in different languages. Double-click the language to show the software manual.

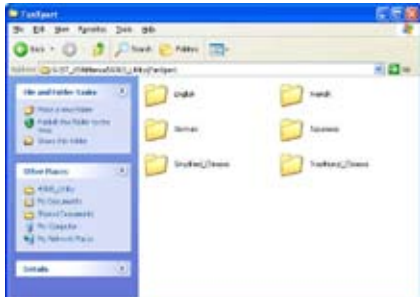

The screenshots in this section are for reference only. The actual software manuals containing in the support DVD vary by models.

## 4.3 Software information

Most of the applications in the support DVD have wizards that will conveniently guide you through the installation. View the online help or readme file that came with the software application for more information.

### 4.3.1 AI Suite II

AI Suite II is an all-in-one interface that integrates several ASUS utilities and allows users to launch and operate these utilities simultaneously.

#### Installing AI Suite II

To install AI Suite II on your computer

1. Place the support DVD to the optical drive. The Drivers installation tab appears if your computer has enabled the Autorun feature.
2. Click the Utilities tab, then click **AI Suite II**.
3. Follow the onscreen instructions to complete installation.

#### Using AI Suite II

AI Suite II automatically starts when you enter the Windows® operating system (OS). The AI Suite II icon appears in the Windows® notification area. Click the icon to open the AI Suite II main menu bar.

Click each button to select and launch a utility, to monitor or update the motherboard BIOS, to display the system information, and to customize the settings of AI Suite II.

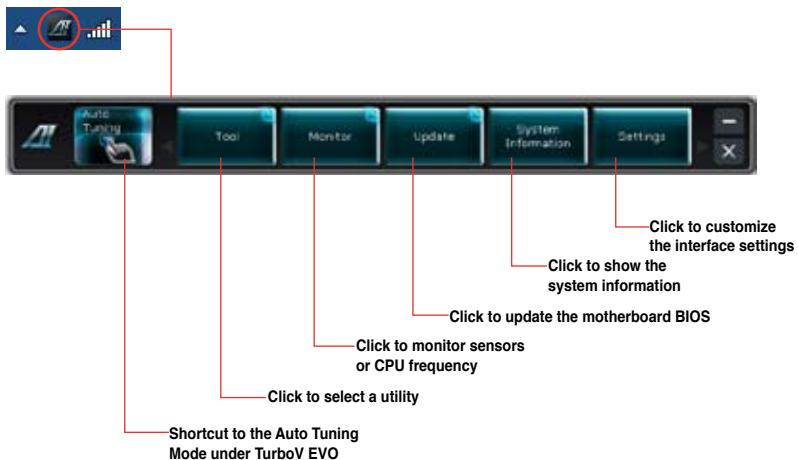

- The **Auto Tuning** button appears only on models with the TurboV EVO function.
- The applications in the Tool menu vary with models.
- The screenshots of AI Suite II in this user manual are for reference only. The actual screenshots vary with models.
- Refer to the software manual in the support DVD or visit the ASUS website at [www.asus.com](http://www.asus.com) for detailed software configuration.

### 4.3.2 DIGI+ VRM

ASUS DIGI+ VRM allows you to adjust VRM voltage and frequency modulation to enhance reliability and stability. It also provides the highest power efficiency, generating less heat to longer component lifespan and minimize power loss.

After installing AI Suite II from the motherboard support DVD, launch DIGI+ VRM by clicking **Tool > DIGI+ VRM** on the AI Suite II main menu bar.



Function no.	Function description
1	<b>DIGI+ VRM Load-line Calibration</b> Higher load-line calibration could get higher voltage and good overclocking performance but increase the CPU and VRM thermal.
2	<b>DIGI+ VRM CPU Current Capability</b> DIGI+ VRM CPU Current Capability provides wider total power range for overclocking. A higher value setting gets higher VRM power consumption delivery.
3	<b>DIGI+ VRM Frequency</b> Switching frequency will affect the VRM transient response and component thermal. Higher frequency gets quicker transient response.
4	<b>DIGI+ VRM Phase Control</b> Increase phase number under heavy system loading to get more transient and better thermal performance. Reduce phase number under light system loading to increase VRM efficiency.
5	<b>DIGI+ VRM Duty Control</b> DIGI+ VRM Duty Control adjusts the current of every VRM phase and the thermal of every phase component.
6	<b>iGPU Load-line Calibration</b> Higher value could get higher iGPU voltage and good performance but increase the CPU and VRM thermal.
7	<b>iGPU Current Capability</b> A higher value brings a wider total iGPU power and overclocking frequency range to enhance iGPU performance..



- The actual performance boost may vary depending on your CPU specification.
- Do not remove the thermal module. The thermal conditions should be monitored.



Refer to the software manual in the support DVD or visit the ASUS website at [www.asus.com](http://www.asus.com) for detailed software configuration.

### 4.3.3 BT GO!



BT GO! connects a bluetooth (BT) device with the motherboard through Bluetooth connection for file transferring, file synchronization, music playback, personal manager, and multiple remote functions.

#### Launching BT GO!

After installing AI Suite II from the motherboard support DVD, launch **BT GO!** by clicking **Tool > BT GO!** on the AI Suite II main menu bar.

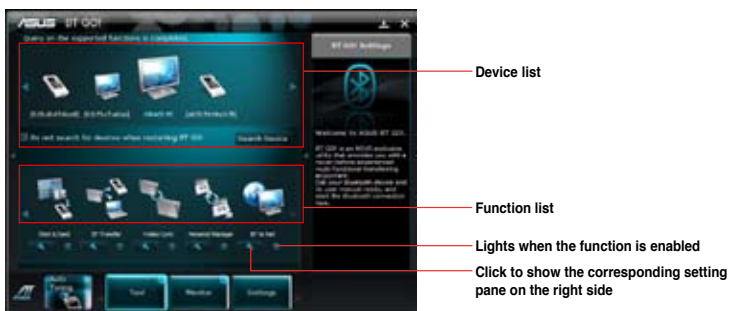
#### Using BT GO!



- Click  and  to scroll the device list and the function list.
- Click any of the device icons to select the device as the connected BT device and **BT GO!** will automatically search for the supported functions for the selected device.
- Click any of the device / function icons to connect the selected device and enable / disable the selected function.

#### Function introduction

**Shot & Send:** allows you to snap and transfer the screenshot to the connected BT device.

**BT Transfer:** allows you to share the files stored in the host BT device to another connected BT devices.

**Folder Sync:** allows you to sync or back up the selected folder between the selected BT devices and the computer.

**Personal Manager:** allows you to synchronize the personal contacts and calendar information between the BT device and the system.

**BT to Net:** allows the system to access the Internet via the network shared by the Bluetooth device.

**Music Player:** allows you to play the selected music files in the BT device through the computer's speakers.

**BT Turbo Remote:** provides a user-friendly interface that allows you to use your smartphone as the remote controller via the bluetooth connection for the **BT Turbo Key**, **Pocket Media**, and **Reset/Off** functions.



- Refer to the software manual in the support DVD or visit the ASUS website at [www.asus.com](http://www.asus.com) for detailed software configuration.
  - The Bluetooth word mark and logos are owned by the Bluetooth SIG, Inc. and any use of such marks by ASUSTek Computer Inc. is under license. Other trademarks and trade names are those of their respective owners.
-



### 4.3.4 TurboV EVO

ASUS TurboV EVO introduces **TurboV** that allows you to manually adjust the CPU frequency and related voltages as well as **Auto Tuning** function that offers automatic and easy overlocking and system level up. After installing AI Suite II from the motherboard support DVD, launch TurboV EVO by clicking **Tool > TurboV EVO** on the AI Suite II main menu bar.



Refer to the software manual in the support DVD or visit the ASUS website at [www.asus.com](http://www.asus.com) for detailed software configuration.

#### TurboV

**TurboV** allows you to overclock the BCLK frequency, CPU voltage, IMC voltage, and DRAM Bus voltage in Windows® environment and takes effect in real-time without exiting and rebooting the OS.



Refer to the CPU documentation before adjusting CPU voltage settings. Setting a high voltage may damage the CPU permanently, and setting a low voltage may make the system unstable.



For system stability, all changes made in **TurboV** will not be saved to BIOS settings and will not be kept on the next system boot. Use the **Save Profile** function to save your customized overclocking settings and manually load the profile after Windows starts.

**Auto Tuning Mode**

**TurboV Load profile Target values**

**Current values**

**Click to show / hide more settings**

**Click to restore all start-up settings**

**Save the current settings as a new profile**

**Voltage Adjustment bars**

**Undoes all changes without applying**

**Applies all changes immediately**



For advanced overclock ability, adjust first the BIOS items, and then proceed more detailed adjustments in **More Settings**.

## Using Advanced Mode

Click **More Settings**, and then click the **Advanced Mode** tab to adjust the advanced voltage settings.



## GPU Boost

GPU Boost overlocks the integrated iGPU for the best graphics performance.

1. Click **More Settings**, and then click the **GPU Boost** tab.
2. Adjust the **iGPU Max Frequency** and **iGPU Voltage**, then you will be requested to restart the system. Click **Yes** to make the change take effect.



## CPU Ratio

Allows you to manually adjust the CPU ratio.



The first time you use **CPU Ratio**, go to **AI Tweaker > CPU Power Management** in BIOS and set the **Turbo Ratio** item to **[Maximum Turbo Ratio setting in OS]**, or activate CPU Ratio by clicking the ON button on the CPU Ratio function screen.

1. Click **More Settings**, and then click the **CPU Ratio** tab.
2. Click the ON button to activate CPU Ratio.
3. You will be requested to restart the system. Click **Yes** to make the change take effect.



4. Drag the adjustment bar upwards or downwards to the desired value.



- Set the **CPU Ratio Setting** item in BIOS to **[Auto]** before using the CPU Ratio function in TurboV. Refer to Chapter 3 of your motherboard user manual for details.
- The CPU Ratio bars show the status of the CPU cores, which vary with your CPU model.

## Auto Tuning

ASUS TurboV EVO includes two auto tuning modes, providing the most flexible auto-tuning options.



- The overclocking result varies with the CPU model and the system configuration.
- To prevent overheating from damaging the motherboard, a better thermal environment is strongly recommended.

- **Fast Tuning:** fast CPU overclocking
- **Extreme Tuning:** extreme overclocking for CPU and memory

### Using Fast Tuning

1. Click the **Auto Tuning** tab and then click **Fast**.
2. Read through the warning messages and click **OK** to start auto-overclocking.



3. TurboV automatically overclocks the CPU, saves BIOS settings and restarts the system. After re-entering Windows, a message appears indicating auto tuning success. Click **OK** to exit.



### Using Extreme Tuning

1. Click the **Auto Tuning** tab and then click **Extreme**.
2. Read through the warning messages and click **OK** to start auto-overclocking.



- TurboV automatically overclocks the CPU and memory and restarts the system. After re-entering Windows, a message appears indicating the current overclocking result. To keep the result, click **Stop**.



- If you did not click **Stop** in the previous step, TurboV automatically starts further system overclocking and stability test. An animation appears indicating the overclocking process. Click **Stop** if you want to cancel the Overclocking process.



- TurboV automatically adjusts and saves BIOS settings and restarts the system. After re-entering Windows, a message appears indicating auto tuning success. Click **OK** to exit.



### 4.3.5 EPU

EPU is an energy-efficient tool that satisfies different computing needs. This utility provides several modes that you can select to save system power. Selecting Auto mode will have the system shift modes automatically according to current system status. You can also customize each mode by configuring settings like CPU frequency, GPU frequency, vCore Voltage, and Fan Control.

#### Launching EPU

After installing AI Suite II from the motherboard support DVD, launch EPU by clicking **Tool > EPU** on the AI Suite II main menu bar.

The screenshot shows the ASUS EPU Control Panel interface. On the left, there are three mode selection buttons: 'Auto', 'High performance', and 'Max. power saving'. The main area features a central pentagonal graphic with five points labeled 'Performance', 'Convenience', 'Energy saved', 'Reliability', and 'Transparency'. On the right, an 'EPU Status' window is open, showing the current mode as 'Auto-Max. power saving' and a list of components (CPU, GPU, vCore, Fan, vRAM, vGPU) with icons that are lit up to indicate power saving engine activation. Below this, it shows 'Reduced CO2 Emission' (142,383 kg), 'Time Started' (2010/09/29 10:10), and 'Current CPU Power' (3.55 Watts). At the bottom, there are buttons for 'Auto Tuning', 'Tool', 'Monitor', 'Update', and 'System Information'. A separate window at the top right displays a message: 'An error occurred. Please check the connection between the CPU and the GPU. Please restart the system.' Red callout lines connect these elements to descriptive text labels.

- Displays the following message if no VGA power saving engine is detected.
- Displays current mode
- The items lighting up means power saving engine is activated
- Displays the amount of CO2 reduced
- \*Shifts between the display of Total and Current CO2 reduced
- Displays the current CPU power
- Advanced settings for each mode
- Displays the system properties of each mode
- Multiple system operating modes



- \* Select **From EPU Installation** to show the CO2 that has been reduced since you installed EPU.
- \* Select **From the Last Reset** to show the total CO2 that has been reduced since you click the Clear button .
- \* Refer to the software manual in the support DVD or visit the ASUS website at [www.asus.com](http://www.asus.com) for detailed software configuration.

### 4.3.6 ASUS FAN Xpert

Asus Fan Xpert allows you to adjust both the CPU and chassis fan speeds according to different ambient temperatures and your PC's system loading. The various fan profiles offer flexible controls of fan speeds to achieve a quiet and cool system environment.

#### Launching FAN Xpert

After installing AI Suite II from the motherboard support DVD, launch FAN Xpert by clicking **Tool > Fan Xpert** on the AI Suite II main menu bar.

#### Using FAN Xpert

Click **Fan Name** to select a fan and then click **Setting** to select a preset mode for your selected fan.

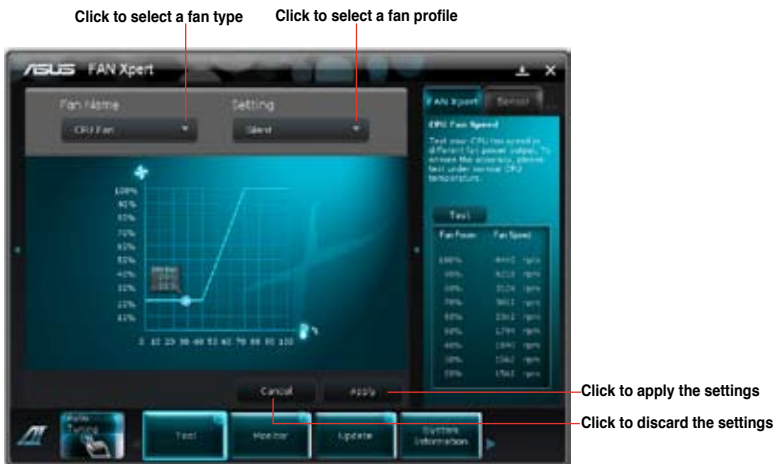

#### Fan setting

- **Disable:** disables the Fan Xpert function.
- **Standard:** adjusts fan speed in a moderate pattern.
- **Silent:** minimizes fan speed for quiet fan operation.
- **Turbo:** maximizes the fan speed for the best cooling effect.
- **Intelligent:** automatically adjusts the CPU fan speed according to the ambient temperature.
- **Stable:** fixes the CPU fan speed to avoid noise caused by the unsteady fan rotation. However, the fan will speed up when the temperature exceeds 70°C.
- **User:** Allows you to configure the CPU fan profile under certain limitations.



Refer to the software manual in the support DVD or visit the ASUS website at [www.asus.com](http://www.asus.com) for detailed software configuration.

### 4.3.7 ASUS Probe II

ASUS Probe II is a utility that monitors the computer's vital components, and detects and alerts you of any problem with these components. Probe II senses fan rotations, CPU temperature, and system voltages, among others. With this utility, you are assured that your computer is always at a healthy operating condition.

#### Launching Probe II

After installing AI Suite II from the motherboard support DVD, launch Probe II by clicking **Tool > Probe II** on the AI Suite II main menu bar.

#### Configuring Probe II

Click the **Voltage/Temperature/Fan Speed** tabs to activate the sensors or to adjust the sensor threshold values. The **Preference** tab allows you to customize sensor alerts, or change the temperature scale.



Saves your configuration

Loads your saved configuration

Loads the default threshold values for each sensor

Applies your changes



## 4.3.8 Ai Charger+

Battery Charging Version 1.1 (BC 1.1), a USB Implementers Forum (USB-IF) certified USB charging function, is designed to make USB charging faster than the standard USB devices. If your USB device supports the BC 1.1 function\*, when you connect your USB device to your system, the system automatically detects your USB device and starts a fast USB charging. The charging speed may get 3 times faster than that of the standard USB devices\*\*.



- \* Check your USB device manufacturer if it fully supports the BC 1.1 function.
- \*\* The actual charging speed may vary with your USB device's conditions.
- Ensure to remove and reconnect your USB device after enabling or disabling Ai Charger+ to ensure normal charging function.



### 4.3.9 Audio configurations

The Realtek® audio CODEC provides 8-channel audio capability to deliver the ultimate audio experience on your computer. The software provides Jack-Detection function, S/PDIF Out support, and interrupt capability. The CODEC also includes the Realtek® proprietary UAJ® (Universal Audio Jack) technology for all audio ports, eliminating cable connection errors and giving users plug and play convenience.

Follow the installation wizard to install the Realtek® Audio Driver from the support DVD that came with the motherboard package.

If the Realtek audio software is correctly installed, you will find the **Realtek HD Audio Manager** icon on the taskbar. Double-click on the icon to display the Realtek HD Audio Manager.



Realtek HD Audio Manager

#### A. Realtek HD Audio Manager for Windows® Vista™

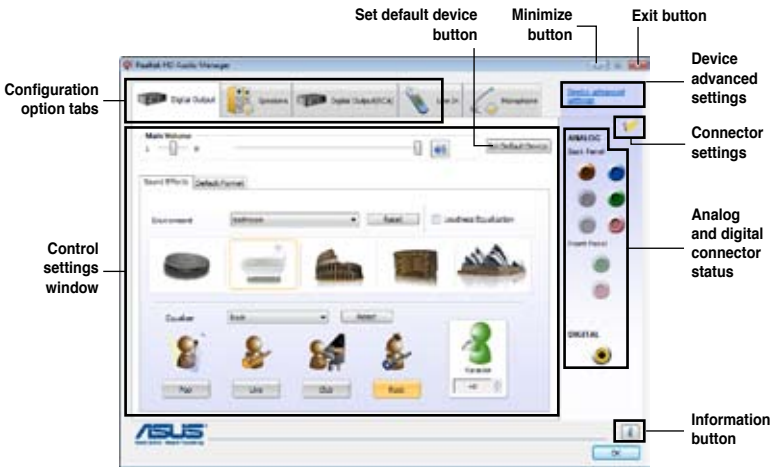

#### B. Realtek HD Audio Manager for Windows XP



Refer to the software manual in the support DVD or visit the ASUS website at [www.asus.com](http://www.asus.com) for detailed software configuration.

## 4.4 RAID configurations

The motherboard supports the following SATA RAID solution:

**Intel® Rapid Storage Technology** with RAID 0, RAID 1, RAID 10 and RAID 5 support.



- You must install Windows® XP Service Pack 3 or later versions before using Serial ATA hard disk drives. The Serial ATA RAID feature is available only if you are using Windows® XP SP3 or later versions.
- Due to Windows® XP / Vista limitation, a RAID array with the total capacity over 2TB cannot be set as a boot disk. A RAID array over 2TB can only be set as a data disk only.
- If you want to install a Windows® operating system to a hard disk drive included in a RAID set, you have to create a RAID driver disk and load the RAID driver during OS installation. Refer to section **4.5 Creating a RAID driver disk** for details.

### 4.4.1 RAID definitions

**RAID 0 (Data striping)** optimizes two identical hard disk drives to read and write data in parallel, interleaved stacks. Two hard disks perform the same work as a single drive but at a sustained data transfer rate, double that of a single disk alone, thus improving data access and storage. Use of two new identical hard disk drives is required for this setup.

**RAID 1 (Data mirroring)** copies and maintains an identical image of data from one drive to a second drive. If one drive fails, the disk array management software directs all applications to the surviving drive as it contains a complete copy of the data in the other drive. This RAID configuration provides data protection and increases fault tolerance to the entire system. Use two new drives or use an existing drive and a new drive for this setup. The new drive must be of the same size or larger than the existing drive.

**RAID 5** stripes both data and parity information across three or more hard disk drives. Among the advantages of RAID 5 configuration include better HDD performance, fault tolerance, and higher storage capacity. The RAID 5 configuration is best suited for transaction processing, relational database applications, enterprise resource planning, and other business systems. Use a minimum of three identical hard disk drives for this setup.

**RAID 10** is data striping and data mirroring combined without parity (redundancy data) having to be calculated and written. With the RAID 10 configuration you get all the benefits of both RAID 0 and RAID 1 configurations. Use four new hard disk drives or use an existing drive and three new drives for this setup.

## 4.4.2 Installing Serial ATA hard disks

The motherboard supports Serial ATA hard disk drives. For optimal performance, install identical drives of the same model and capacity when creating a disk array.

To install the SATA hard disks for a RAID configuration:

1. Install the SATA hard disks into the drive bays.
2. Connect the SATA signal cables.
3. Connect a SATA power cable to the power connector on each drive.

## 4.4.3 Setting the RAID item in BIOS

You must enable the RAID function in the BIOS Setup before creating RAID set(s) using SATA HDDs. To do this:

1. Enter the BIOS Setup during POST.
2. Go to the **Advanced** menu > **SATA Configuration**, and then press <Enter>.
3. Set the **SATA Mode** item to [RAID Mode].
4. Save your changes, and then exit the BIOS Setup.



Refer to Chapter 3 for details on entering and navigating through the BIOS Setup.



Due to chipset limitation, when set any of SATA ports to RAID mode, all SATA ports run at RAID mode together.

## 4.4.4 Intel® Rapid Storage Technology Option ROM utility

To enter the Intel® Rapid Storage Technology Option ROM utility:

1. Turn on the system.
2. During POST, press <Ctrl> + <I> to display the utility main menu.

```
Intel(R) Rapid Storage Technology - Option ROM - v10.5.1.1070
Copyright(C) 2003-10 Intel Corporation. All Rights Reserved.

[ MAIN MENU ]
1. Create RAID Volume
2. Delete RAID Volume
3. Reset Disks to Non-RAID
4. Recovery Volume Options
5. Acceleration Options
6. Exit

[ DISK/VOLUME INFORMATION ]

RAID Volumes:
None defined.

Physical Devices:
Port Device Model      Serial #      Size  Type/Status (Vol ID)
0  ST3160812AS          9LS0HJA4    149.0GB Non-RAID Disk
1  ST3160812AS          9LS0F4HL    149.0GB Non-RAID Disk
2  ST3160812AS          3LS0JVL8    149.0GB Non-RAID Disk
3  ST3160812AS          9LS0BJ5H    149.0GB Non-RAID Disk

[↑↓]-Select      [ESC]-Exit      [ENTER]-Select Menu
```

The navigation keys at the bottom of the screen allow you to move through the menus and select the menu options.



The RAID BIOS setup screens shown in this section are for reference only and may not exactly match the items on your screen.



The utility supports maximum four hard disk drives for RAID configuration.

## Creating a RAID set

To create a RAID set:

1. From the utility main menu, select **1. Create RAID Volume** and press <Enter>. The following screen appears:

```
Intel(R) Rapid Storage Technology - Option ROM - v10.5.1.1070
Copyright(C) 2003-10 Intel Corporation. All Rights Reserved.

----- [ CREATE VOLUME MENU ] -----
Name: Volume0
RAID Level: RAID0(Stripe)
Disks: Select Disks
Strip Size: 128KB
Capacity: 0.0 GB
Sync: N/A
Create Volume

----- [ HELP ] -----

Enter a unique volume name that has no special characters and is
16 characters or less.

[↑↓]-Change [TAB]-Next [ESC]-Previous Menu [ENTER]-Select
```

2. Enter a name for the RAID set and press <Enter>.
3. When the **RAID Level** item is selected, press the up/down arrow key to select a RAID level to create, and then press <Enter>.
4. When the **Disks** item is selected, press <Enter> to select the hard disk drives you want to include in the RAID set. The **SELECT DISKS** screen appears:

```
----- [ SELECT DISKS ] -----
Port Drive Model Serial # Size Status
0 SMD11G081P2AS 9LS0/N/A 149.0GB Non-RAID Disk
1 ST3160812AS 9LS0F4HL 149.0GB Non-RAID Disk
2 ST3160812AS 3LS0JYL8 149.0GB Non-RAID Disk
3 ST3160812AS 9LS0BJ5H 149.0GB Non-RAID Disk

Select 2 to 6 disks to use in creating the volume.

[↑↓]-Prev/Next [SPACE]-SelectDisk [ENTER]-Done
```

5. Use the up/down arrow key to select a drive, and then press <Space> to select. A small triangle marks the selected drive. Press <Enter> after completing your selection.
6. Use the up/down arrow key to select the stripe size for the RAID array (for RAID 0, 10 and 5 only), and then press <Enter>. The available stripe size values range from 4KB to 128KB. The following are typical values:  
RAID 0: 128KB  
RAID 10: 64KB  
RAID 5: 64KB



---

We recommend a lower stripe size for server systems, and a higher stripe size for multimedia computer systems used mainly for audio and video editing.

---

7. When the **Capacity** item is selected, enter the RAID volume capacity that you want and press <Enter>. The default value indicates the maximum allowed capacity.
8. When the **Create Volume** item is selected, press <Enter>. The following warning message appears:

```
WARNING: ALL DATA ON SELECTED DISKS WILL BE LOST.  
Are you sure you want to create this volume? (Y/N):
```

9. Press <Y> to create the RAID volume and return to the main menu, or <N> to go back to the **CREATE VOLUME** menu.

## Deleting a RAID set



Take caution when deleting a RAID set. You will lose all data on the hard disk drives when you delete a RAID set.

To delete a RAID set:

1. From the utility main menu, select **2. Delete RAID Volume** and press <Enter>. The following screen appears:

```
Intel(R) Rapid Storage Technology - Option ROM - v10.5.1.1070
Copyright(C) 2003-10 Intel Corporation. All Rights Reserved.

[ DELETE VOLUME MENU ]

Name      Level      Drives  Capacity  Status  Bootable
Volume0   RAID0 (Stripe)  2       298.0GB  Normal  Yes

[ HELP ]

Deleting a volume will reset the disks to non-RAID.
WARNING: ALL DISK DATA WILL BE DELETED.
(This does not apply to Recovery volumes)

[↑↓]-Select      [ESC]-Previous Menu  [DEL]-Delete Volume
```

2. Use the up/down arrow key to select the RAID set you want to delete, and then press <Del>. The following warning message appears:

```
[ DELETE VOLUME VERIFICATION ]

ALL DATA IN THE VOLUME WILL BE LOST!
(This does not apply to Recovery volumes)

Are you sure you want to delete volume "Volume0"? (Y/N) :
```

3. Press <Y> to delete the RAID set and return to the utility main menu, or press <N> to return to the **DELETE VOLUME** menu.

## Exiting the Intel® Rapid Storage Technology Option ROM utility

To exit the utility:

1. From the utility main menu, select **5. Exit**, and then press <Enter>. The following warning message appears:

```
[ CONFIRM EXIT ]

Are you sure you want to exit? (Y/N) :
```

2. Press <Y> to exit or press <N> to return to the utility main menu.

## Intel® Smart Response Technology

Intel® Smart Response Technology boosts overall system performance. It uses an installed fast SSD (min 18.6GB available) as a cache for frequently accessed operations, speeding up hard drive/ main memory interaction. Key benefits are expedited hard drive speeds, reduced load and wait times, and maximized storage utilization. Power consumption also goes down by reducing unnecessary hard drive spin.



- Intel® Smart Response Technology supports Windows® 7/ Vista operating systems.
- Intel® Smart Response Technology is supported by 2nd generation Intel® Core™ processor family.
- Operating systems must be installed on the HDD to launch Intel® Smart Response Technology. The capacity of the SSD is reserved for caching function.
- Before applying Intel® Smart Response Technology, set the **SATA Mode BIOS** item to [RAID mode] in BIOS setup. Refer to section **3.5.4 SATA Configuration** for details.

To install Intel® Smart Response Technology:

1. Place the support DVD to the optical drive. The Drivers installation tab appears if your computer has enabled the Autorun feature.
2. Click the Drivers tab, then click Intel® Rapid Storage Technology Driver software.
3. Follow the onscreen instructions to complete installation.

To use Intel® Smart Response Technology:

1. Click **Accelerate** to launch Smart Response Technology settings.  

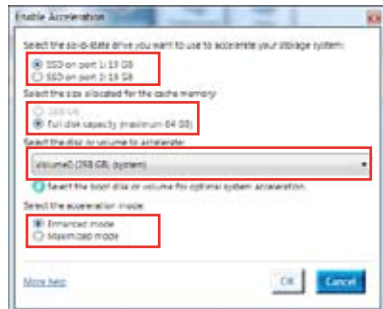
2.
  - a. Select the SSD you want to use to accelerate your storage system.
  - b. Select the size allocated for SSD caching.
  - c. Select which HDD for caching.
  - d. **Enhanced mode**:WRITE THROUGH, write to SSD and HDD at the same time.  
**Maximized mode**:WRITE BACK, write to SSD and write back to HDD in a later time.





3. Select **Disable Acceleration** to disable this function and select **Change Mode** to switch acceleration mode to Enhanced/Maximus.



- Only Intel® internal SATA ports (gray and blue) support Intel® Smart Response Technology.
- You need at least one SSD (>18.6GB) and one HDD as a set to enable Intel® Smart Response Technology. A single SSD can only be assigned to one HDD for caching.
- The maximum caching size on the SSD is 64GB. If the SSD exceeds 64GB, storage capacity left out of caching can still be identified by the system for normal storage.
- Be sure to disable the acceleration function of Intel® Smart Response Technology under OS when applying the actions below:
  - Removing or replacing the SSD
  - Updating IRST 10.5 driver
  - Updating BIOS
- If you want to restore the OS, go to BIOS Option ROM utility and select Acceleration Options to disable Intel® Smart Response Technology.
- The performance of Intel® Smart Response Technology varies by SSD.

## 4.5 Creating a RAID driver disk

A floppy disk with the RAID driver is required when installing a Windows® operating system on a hard disk drive that is included in a RAID set.



- **The motherboard does not provide a floppy drive connector.** You have to use a USB floppy disk drive when creating a **SATA** RAID driver disk.
- Windows® XP may not recognize the USB floppy disk drive due to Windows® XP limitation. To work around this OS limitation, refer to section **4.5.4 Using a USB floppy disk drive**.

### 4.5.1 Creating a RAID driver disk without entering the OS

To create a RAID driver disk without entering the OS:

1. Boot your computer.
2. Press <Del> during POST to enter the BIOS setup utility.
3. Set the optical drive as the primary boot device.
4. Insert the support DVD into the optical drive.
5. Save changes and exit BIOS.
6. When the **Make Disk** menu appears, press <1> to create a RAID driver disk.
7. Insert a formatted floppy disk into the USB floppy disk drive, then press <Enter>.
8. Follow the succeeding screen instructions to complete the process.

### 4.5.2 Creating a RAID driver disk in Windows®

To create a RAID driver disk in Windows®:

1. Start Windows®.
2. Plug the USB floppy disk drive and insert a floppy disk.
3. Place the motherboard support DVD into the optical drive.
4. Go to the **Make Disk** menu, and then click **Intel AHCI/RAID Driver Disk** to create a RAID driver disk.
5. Select USB floppy disk drive as the destination disk.
6. Follow the succeeding screen instructions to complete the process.



---

Write-protect the floppy disk to avoid a computer virus infection.

---

### 4.5.3 Installing the RAID driver during Windows® OS installation

To install the RAID driver in Windows® XP:

1. During the OS installation, the system prompts you to press the F6 key to install third-party SCSI or RAID driver.
2. Press <F6>, and then insert the floppy disk with RAID driver into the USB floppy disk drive.
3. When prompted to select the SCSI adapter to install, select the RAID driver for the corresponding OS version.
4. Follow the succeeding screen instructions to complete the installation.

To install the RAID driver for Windows® Vista or later OS:

1. During the OS installation, click **Load Driver** to allow you to select the installation media containing the RAID driver.
2. Insert the USB flash drive with RAID driver into the USB port or the support DVD into the optical drive, and then click **Browse**.
3. Click the name of the device you've inserted, go to **Drivers > RAID**, and then select the RAID driver for the corresponding OS version. Click **OK**.
4. Follow the succeeding screen instructions to complete the installation.



---

Before loading the RAID driver from a USB flash drive, you have to use another computer to copy the RAID driver from the support DVD to the USB flash drive.

---

## 4.5.4 Using a USB floppy disk drive

Due to OS limitation, Windows® XP may not recognize the USB floppy disk drive when you install the RAID driver from a floppy disk during the OS installation.

To solve this issue, add the USB floppy disk drive's Vendor ID (VID) and Product ID (PID) to the floppy disk containing the RAID driver. Refer to the steps below:

1. Using another computer, plug the USB floppy disk drive, and insert the floppy disk containing the RAID driver.
2. Right-click **My Computer** on the Windows® desktop or **start** menu, and then select **Manage** from the pop-up window.

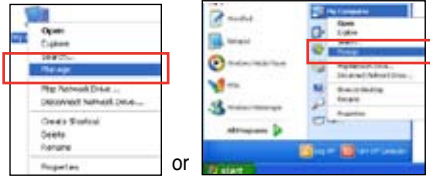

3. Select **Device Manager**. From the **Universal Serial Bus controllers**, right-click **xxxxxx USB Floppy**, and then select **Properties** from the pop-up window.



The name of the USB floppy disk drive varies with different vendors.

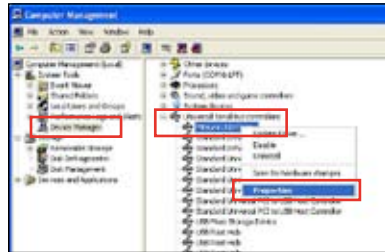

4. Click **Details** tab. The Vendor ID (VID) and Product ID (PID) are displayed.

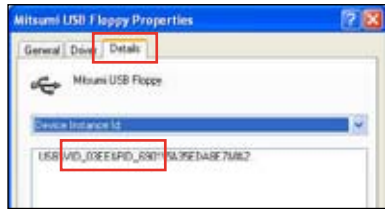

5. Browse the contents of the RAID driver disk to locate the file **txtsetup.oem**.
6. Double-click the file. A window appears, allowing you to select the program for opening the oem file.

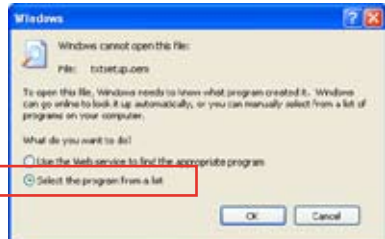

7. Use Notepad to open the file.



8. Find the `[HardwareIds.scsi.iaAHCI_DesktopWorkstationServer]` and `[HardwareIds.scsi.iaStor_DesktopWorkstationServer]` sections in the `txtsetup.oem` file.
9. Type the following line to the bottom of the two sections:  
`id= "USB\VID_xxxx&PID_xxxx", "usbstor"`

```
[HardwareIds.scsi.iaAHCI_DesktopWorkstationServer]
id= "PCI\VEN_8086&DEV_1C02&CC_0106", "iaStor"
id= "USB\VID_03EE&PID_6901", "usbstor"

[HardwareIds.scsi.iaStor_DesktopWorkstationServer]
id= "PCI\VEN_8086&DEV_2822&CC_0104", "iaStor"
id= "USB\VID_03EE&PID_6901", "usbstor"
```



Add the same line to both sections.



The VID and PID vary with different vendors.

10. Save and exit the file.



## 5.1 ATI® CrossFireX™ technology

The motherboard supports the ATI® CrossFireX™ technology that allows you to install multi-graphics processing units (GPU) graphics cards. Follow the installation procedures in this section.

### 5.1.1 Requirements

- In Dual CrossFireX mode, you should have two identical CrossFireX-ready graphics cards or one CrossFireX-ready dual-GPU graphics card that are ATI® certified.
- Ensure that your graphics card driver supports the ATI CrossFireX technology. Download the latest driver from the AMD website ([www.amd.com](http://www.amd.com)).
- Ensure that your power supply unit (PSU) can provide at least the minimum power required by your system. See Chapter 2 for details.



- 
- We recommend that you install additional chassis fans for better thermal environment.
  - Visit the ATI Game website (<http://game.amd.com>) for the latest certified graphics card and the supported 3D application list.
- 

### 5.1.2 Before you begin

For ATI CrossFireX to work properly, you have to uninstall all existing graphics card drivers before installing ATI CrossFireX graphics cards to your system.

To uninstall existing graphics card drivers:

1. Close all current applications.
2. For Windows XP, go to **Control Panel > Add/Remove Programs**.  
For Windows Vista, go to **Control Panel > Programs and Features**.
3. Select your current graphics card driver/s.
4. For Windows XP, select **Add/Remove**.  
For Windows Vista, select **Uninstall**.
5. Turn off your computer.

### 5.1.3 Installing two CrossFireX™ graphics cards



The following pictures are for reference only. The graphics cards and the motherboard layout may vary with models, but the installation steps remain the same.

1. Prepare two CrossFireX-ready graphics cards.
2. Insert the two graphics card into the PCIEX16 slots. If your motherboard has more than two PCIEX16 slots, refer to Chapter 2 in this user manual for the locations of the PCIEX16 slots recommended for multi-graphics card installation.
3. Ensure that the cards are properly seated on the slots.
4. Align and firmly insert the CrossFireX bridge connector to the goldfingers on each graphics card. Ensure that the connector is firmly in place.

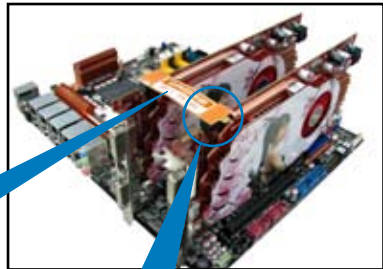
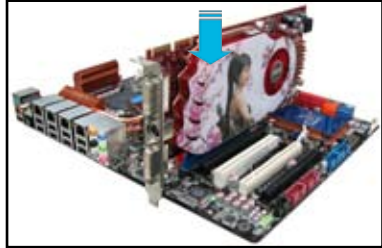

CrossFireX bridge  
(bundled with  
graphics cards)

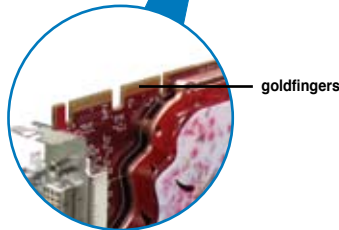

5. Connect two independent auxiliary power sources from the power supply to the two graphics cards separately.
6. Connect a VGA or a DVI cable to the graphics card.

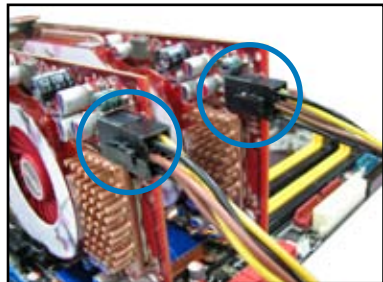



### 5.1.4 Installing the device drivers

Refer to the documentation that came with your graphics card package to install the device drivers.



Ensure that your PCI Express graphics card driver supports the ATI® CrossFireX™ technology. Download the latest driver from the AMD website ([www.amd.com](http://www.amd.com)).

### 5.1.5 Enabling the ATI® CrossFireX™ technology

After installing your graphics cards and the device drivers, enable the CrossFireX™ feature through the ATI Catalyst™ Control Center in Windows environment.

#### Launching the ATI Catalyst Control Center

To launch the ATI Catalyst Control Center:

1. Right-click on the Windows® desktop and select **Catalyst(TM) Control Center**. You can also right-click the ATI icon in the Windows notification area and select **Catalyst Control Center**.

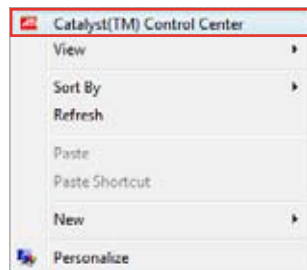

2. The **Catalyst Control Center Setup Assistant** appears when the system detects the existence of multi-graphics cards. Click **Go** to continue to the **Catalyst Control Center Advanced View** window.



#### Enabling Dual CrossFireX technology

1. In the Catalyst Control Center window, click **Graphics Settings > CrossFireX > Configure**.
2. From the Graphics Adapter list, select the graphics card to act as the display GPU.
3. Select **Enable CrossFireX**.
4. Click **Apply**, and then click **OK** to exit the window.



## 5.2 NVIDIA® SLI™ technology

The motherboard supports the NVIDIA® SLI™ (Scalable Link Interface) technology that allows you to install multi-graphics processing units (GPU) graphics cards. Follow the installation procedures in this section.

### 5.2.1 Requirements

- In SLI mode, you should have two identical SLI-ready graphics cards that are NVIDIA® certified.
- Ensure that your graphics card driver supports the NVIDIA SLI technology. Download the latest driver from the NVIDIA website ([www.nvidia.com](http://www.nvidia.com)).
- Ensure that your power supply unit (PSU) can provide at least the minimum power required by your system. See Chapter 2 for details.



- We recommend that you install additional chassis fans for better thermal environment.
- Visit the NVIDIA zone website (<http://www.nzone.com>) for the latest certified graphics card and supported 3D application list.

### 5.2.2 Installing two SLI-ready graphics cards



The following pictures are for reference only. The graphics cards and the motherboard layout may vary with models, but the installation steps remain the same.

1. Prepare two SLI-ready graphics cards.
2. Insert the two graphics card into the PCIEX16 slots. If your motherboard has more than two PCIEX16 slots, refer to Chapter 2 in this user manual for the locations of the PCIEX16 slots recommended for multi-graphics card installation.
3. Ensure that the cards are properly seated on the slots.

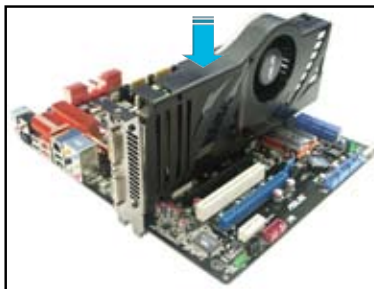

4. Align and firmly insert the SLI bridge connector to the goldfingers on each graphics card. Ensure that the connector is firmly in place.
5. Connect two independent auxiliary power sources from the power supply to the two graphics cards separately.
6. Connect a VGA or a DVI cable to the graphics card.

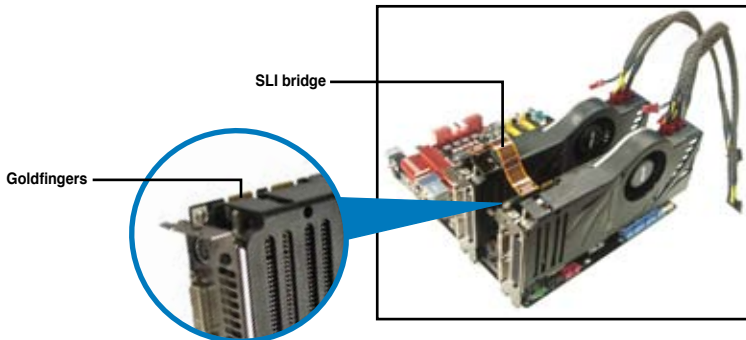

### 5.2.3 Installing the device drivers

Refer to the documentation that came with your graphics card package to install the device drivers.



Ensure that your PCI Express graphics card driver supports the NVIDIA® SLI™ technology. Download the latest driver from the NVIDIA website ([www.nvidia.com](http://www.nvidia.com)).

### 5.2.4 Enabling the NVIDIA® SLI™ technology

After installing your graphics cards and the device drivers, enable the SLI feature in NVIDIA® Control Panel under the Windows® Vista™ operating system.

#### Launching the NVIDIA Control Panel

You can launch the NVIDIA Control Panel by the following two methods.

- A. Right click on the empty space of the Windows® desktop and select **NVIDIA Control Panel**.

The NVIDIA Control Panel window appears (See Step B5).

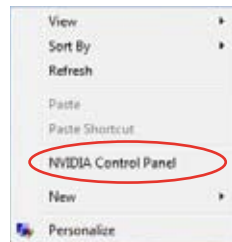

- B1. If you cannot see the NVIDIA Control Panel item in step (A), select **Personalize**.

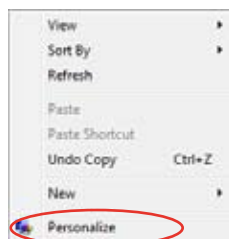

- B2. From the **Personalization** window, select **Display Settings**.

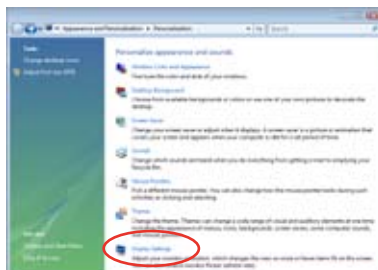

- B3. From the Display Settings dialog box, click **Advanced Settings**.

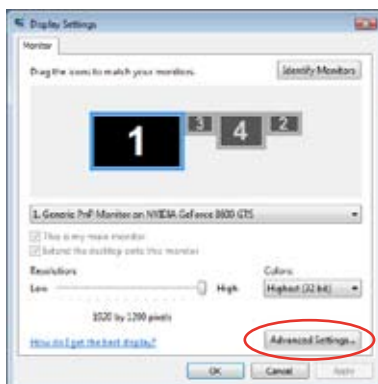

- B4. Select the NVIDIA GeForce tab, and then click **Start the NVIDIA Control Panel**.



- B5. The NVIDIA Control Panel window appears.

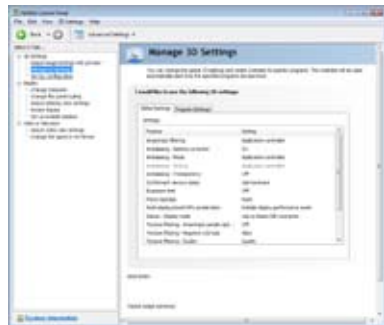

### Enabling SLI settings

From the NVIDIA Control Panel window, select **Set SLI Configuration**. Click **Enable SLI** and set the display for viewing SLI rendered content. When done, click **Apply**.



## 5.3 LucidLogix® Virtu™ solution

LucidLogix® Virtu™ is a new generation GPU virtualization software that blurs the line between embedded graphics and discrete GPU for increased graphics performance. Its GPU virtualization dynamically assigns tasks to the best available graphics resources based on power, performance and system load. It allows users to fully utilize the unique capabilities of advanced Sandy Bridge multimedia features alongside the high end 3D rendering performance provided by installed graphics cards. For users with diverse needs, LucidLogix® Virtu™ GPU virtualization provides great flexibility and efficiency.



- LucidLogix® Virtu™ supports Windows® 7 operating systems.
- Intel® Quick Sync Video feature is supported by 2nd generation Intel® Core™ processor family.
- iGPU Multi-Monitor support option has to be enabled in BIOS before installing LucidLogix® Virtu™.
- Supports NVIDIA® GF4xx/ 5xx series & AMD® HD5xxx/ 6xxx series graphic cards.

### 5.3.1 Hardware installation

To install LucidLogix® Virtu™:

1. Place the support DVD to the optical drive. The Drivers installation tab appears if your computer has enabled the Autorun feature.
2. Click the Drivers tab, then click LucidLogix® Virtu™ software.
3. Follow the onscreen instructions to complete installation.

#### i-Mode

To use LucidLogix® Virtu™ solution in i-Mode, display must be always connected to Sandy Bridge motherboard video output.



Be sure to set Initial Graphic Adaptor to iGPU in BIOS to activate i-Mode support.

#### d-Mode (recommended mode)

To use LucidLogix® Virtu™ solution in d-Mode, display must be connected to the discrete GPU installed in the system.



Be sure to set Initial Graphic Adaptor to PCIe or PCIe/ PCI in BIOS to enable d-Mode support.

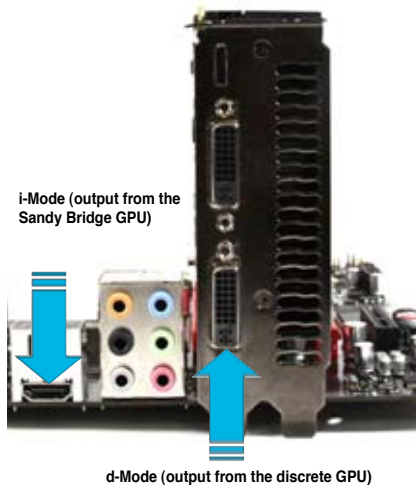

Both i-Mode and d-Mode enjoy the performance of Intel® Sandy Bridge built-in media features and discrete card. d-Mode is recommended for enhanced 3D gaming performance.

### 5.3.2 Software configuration

After you successfully installed the LucidLogix® Virtu™ from the support DVD that comes with your motherboard package, a LucidLogix® Virtu™ icon appears in the notification area.

To enable LucidLogix® Virtu™

1. Right-click LucidLogix® Virtu™ icon in the notification area and select **Enable Virtu**.
2. LucidLogix® Virtu™ is enabled.

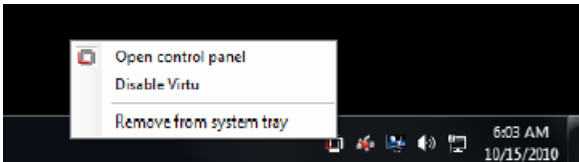
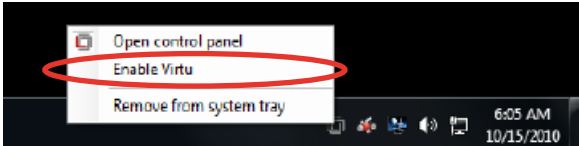

---

LucidLogix® Virtu™ is automatically activated when your system is powered on. Select **Remove from system tray**, if you want to remove LucidLogix® Virtu™.

---

To open the control panel

1. Right-click LucidLogix® Virtu™ icon in the notification area and select **Open control panel**.
2. In the Main tab, you can check the LucidLogix® Virtu™ status and customize your settings.

Check your current display mode, i-mode (blue) or d-Mode (green)



Adjust Performance optimization,  
Quality over Performance or  
Performance over Quality

Select the way to show the Lucid  
icon when you are in game.



## **ASUS contact information**

### **ASUSTeK COMPUTER INC.**

Address	15 Li-Te Road, Peitou, Taipei, Taiwan 11259
Telephone	+886-2-2894-3447
Fax	+886-2-2890-7798
E-mail	info@asus.com.tw
Web site	www.asus.com.tw

#### ***Technical Support***

Telephone	+86-21-38429911
Online support	support.asus.com

### **ASUS COMPUTER INTERNATIONAL (America)**

Address	800 Corporate Way, Fremont, CA 94539, USA
Telephone	+1-812-282-3777
Fax	+1-510-608-4555
Web site	usa.asus.com

#### ***Technical Support***

Telephone	+1-812-282-2787
Support fax	+1-812-284-0883
Online support	support.asus.com

### **ASUS COMPUTER GmbH (Germany and Austria)**

Address	Harkort Str. 21-23, D-40880 Ratingen, Germany
Fax	+49-2102-959911
Web site	www.asus.de
Online contact	www.asus.de/sales

#### ***Technical Support***

Telephone	+49-1805-010923*
Support Fax	+49-2102-9599-11
Online support	support.asus.com

\* EUR 0.14/minute from a German fixed landline; EUR 0.42/minute from a mobile phone.

# DECLARATION OF CONFORMITY

Per FCC Part 2 Section 2.1077(e)



Responsible Party Name: **Asus Computer International**

Address: **800 Corporate Way, Fremont, CA 94539.**

Phone/Fax No: **(510)739-3777/(510)608-4555**

hereby declares that the product

**Product Name : Motherboard**

**Model Number : P8Z68-V PRO**

Conforms to the following specifications:

- FCC Part 15, Subpart B, Unintentional Radiators
- FCC Part 15, Subpart C, Intentional Radiators
- FCC Part 15, Subpart E, Intentional Radiators

### Supplementary Information:

This device complies with part 15 of the FCC Rules. Operation is subject to the following two conditions: (1) This device may not cause harmful interference, and (2) this device must accept any interference received, including interference that may cause undesired operation.

Representative Person's Name : **Steve Chang / President**

Signature :

Date : **Apr. 12, 2011**

# EC Declaration of Conformity



We, the undersigned,

Manufacturer: **ASUSTeK COMPUTER INC.**  
Address: **No. 150, LI-TE RD., PEITOU, TAIPEI 112, TAIWAN R.O.C.**  
Country: **TAIWAN**  
Authorized representative in Europe: **ASUS COMPUTER GmbH**  
Address: **HARKORT STR. 21-23, 40880 RATINGEN**  
Country: **GERMANY**

declare the following apparatus:

Product name : **Motherboard**  
Model name : **P8Z68-V PRO**

conform with the essential requirements of the following directives:

**2004/108/EC-EMC Directive**

- EN 55022:2006/A1:2007
- EN 55024:2006/A1:2007
- EN 55013:2001/A1:2003/A2:2006
- EN 55022:2007

**1999/5/EC-R&TTE Directive**

- EN 300 328 V1.2 (12006-10)
- EN 300 440-1 V1.4 (12008-05)
- EN 300 440-2 V1.2 (12008-03)
- EN 300 440-3 V1.3 (12002-08)
- EN 300 440-4 V1.3 (12002-08)
- EN 300 440-5 V1.3 (12002-08)
- EN 301 888-1 V3.2 (12007-05)
- EN 301 908-2 V3.2 (12007-05)
- EN 301 908-3 V3.2 (12007-05)
- EN 301 883 V1.4 (12005-03)
- EN 301 883 V1.4 (12005-03)
- EN 301 883 V1.4 (12007-09)
- EN 301 883 V1.4 (12007-09)
- EN 302 328-3 V1.3 (12007-09)
- EN 301 357-2 V1.3 (12006-09)
- EN 50371:2002
- EN 50395:2002

**2006/95/EC-LVD Directive**

- EN 60950-1:2006
- EN 60950-1:2006/A1:2009

**2009/125/EC-ErP Directive**

- Regulation (EC) No. 1275/2008
- EN 62301:2005
- Regulation (EC) No. 642/2009
- EN 62301:2005

Ver. 110101



(EC conformity marking)

Position : **CEO**  
Name : **Jerry Shen**

Signature : \_\_\_\_\_

Declaration Date: **Apr. 12, 2011**  
Year to begin affixing CE marking: **2011**